

Unique

Steel has something new to tell.



BARAZZA
taste of design

A STORY TO BE TOLD

The art of taking care of others has been Barazza's mission for almost fifty years through every one of its products, the outstanding fruit of those years of experience and daily attention to detail. Unique represents the essence of this way of working; it is a new collection designed for you to enter a new dimension of the story. There are no words here: the pictures highlight clear-cut shapes and essential beauty. The tale is entrusted to the sense of touch. The grooves beneath caressing fingers speak of excellence, craftsmanship, creativity and uniqueness. And it's just the beginning of a long story.



IMPERFECTION BECOMES PERFECTION

An apparently spontaneous process, but in reality the result of endless meticulous assessments and fine corrections. This vintage finish is the result of a long preparatory stage reached through an original processing which leaves room also for personal interpretation. The raw material comes to life, sensations are heightened. Everything is ready.

UNIQUE, UNREPEATABLE, ONLY YOURS

The material takes shape under the hands of master craftsmen who transform the cold, shiny steel surface into something extraordinary.

Different craftsmen, who transform the cold, shiny steel surface into something extraordinary. There is no uniformity in vintage steel: the watchword here is the spontaneous beauty that comes from the action.







Every piece is unique, unrepeatable, only yours.

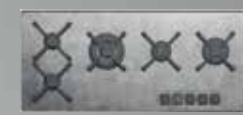

UNIQUE COLLECTION I AM WHAT YOU WANT

A complete collection consisting of ovens, hobs, hoods, sinks and taps, the fusion of craftsmanship and cutting-edge technology. The distinctive vintage effect increases your options to personalize the kitchen, transforming even the household electrical appliances into exclusive, unique pieces of furniture.



<p>#1 Built-in multifunction oven page 14</p>  <p>code 1FUNMV</p>	<p>#2 Built-in multiprogram oven page 15</p>  <p>code 1FUNPV</p>	<p>#3 Built-in hob page 21</p>  <p>code 1PUN105</p>
<p>#4 Wall cooker hood page 27</p>  <p>code 1KUNP12</p>	<p>#5 Built-in sink page 32</p>  <p>code 1LUN81</p>	<p>#6 Mixer tap page 37</p>  <p>code 1RUBUN1</p>



OVENS PERFECTLY COOKED EMOTIONS

The technological excellence is matched by the elegant purity of a minimalist style. As well as blending in with any modern style of furnishings, the ovens with digital or manual controls are also designed to meet all needs: every desire can at last be savoured to the full.



UNIQUE OVENS GENERAL FEATURES AND OPTIONAL ELEMENTS

TRIPLE HEAT REFLECTING INTERNAL GLASS



 This ensures that as much heat as possible remains inside the oven, limiting heat loss to external surfaces and keeping the temperature well below regulatory limits, therefore reducing energy consumption and avoiding a situation where children may burn themselves, upon accidentally touching these surfaces.

100% GLASS INNER DOOR WITH REMOVABLE GLASS

It is made from just one smooth surface that facilitates cleaning operations. The door can be removed to access the glass sheets simply by undoing two screws.

DROP-DOWN GRILL



The drop-down grill makes cleaning the top of the oven cavity extremely easy.

SELF-CLEANING PANELS



The oven is available with self-cleaning panels whose surfaces exploit the effect of the heat in order to start up an automatic cleaning process: grease is turned to ash that can be easily removed with a damp cloth without the use of detergents. If necessary, the panels can be easily removed.



As well as being resistant to impact and to high temperatures it has an elegant shape that makes it suitable for use as a serving tray.

PIZZA PLATE



Plate made of refractory material ideal for pizzas, fancy breads and frozen foods.

TELESCOPIC OVEN RAILS



 Food and cooking instruments are easier to handle and remove thanks to a locking device at the end of the run.

EASY CLEAN OVEN LINING





 The vitreous structure of the Easy Clean enamel makes the surfaces perfectly smooth so that cooking grease and oils simply slide off for easy cleaning. The soft hinges facilitate the door opening and the interior lights make monitoring the contents of the oven easier.

INTERNAL SHELF STABILITY

The side racks give stability to the shelves and make it safe to check dishes. They can also be equipped with telescopic oven rails.

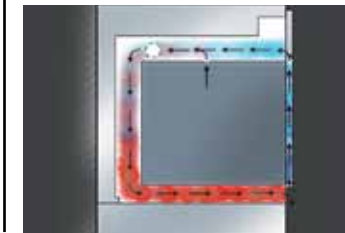
COOLING SYSTEM AND TANGENTIAL COOLING FAN



 It maintains external temperatures within the limits as defined by the safety standards. The tangential cooling fan activates upon oven activation and remains on until the oven is turned off; it normalizes the temperature by producing a flow of cold air.

CAPACITY AND 6 COOKING LEVELS



 Composed of a non-deformable body without visible welded parts, the 65 litre cavity for 60 cm ovens allows to improve cooking times and subsequently electrical energy saving. 6 positions allow you to simultaneously place several dishes in the oven or cook large quantities of food.

UNIQUE OVENS BUILT-IN

60 cm Unique built-in multifunction oven

Energy rating **A**

Accessories: 26 27 28 29



- 8 functions + defrost function
- mechanical 90' timer with buzzer at end of cooking time
- capacity: 65 litres
- features: easy-clean oven lining, extractable and removable door with triple heat-reflecting glass
- maximum temperature: 250°C
- maximum absorbed power: 2.7 kW

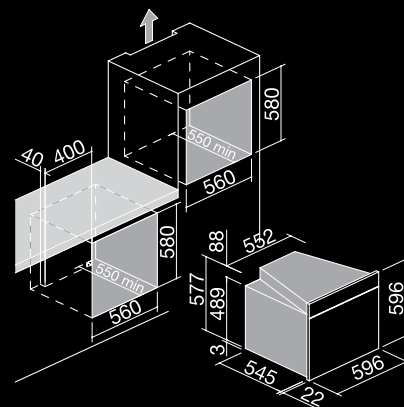

VINTAGE STAINLESS STEEL/BLACK OVEN

code 1FUNMV

UNIQUE OVENS BUILT-IN

60 cm Unique built-in multiprogram oven
Touch Control

Energy rating **A**

Accessories: 26 27 28 29



- 10 functions
- 16 automatic cooking programs
- Touch Control digital programmer
- capacity: 65 litres
- features: easy-clean oven lining, extractable and removable door with triple heat-reflecting glass
- safety devices: electronic child safety lock
- maximum temperature: 250°C
- maximum absorbed power: 2.7 kW

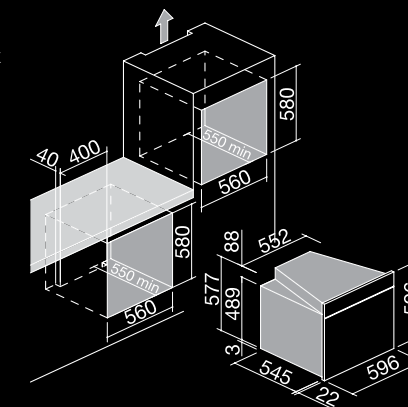

VINTAGE STAINLESS STEEL/BLACK OVEN

code 1FUNPV



Accessories



Standard features: tangential cooling fan, side racks, 2 side lights, easy-clean enamelled steel tray, 2 stainless steel shelves, drop-down grill.

OVEN FUNCTIONS

Static oven

Top heating element + bottom heating element.
For any dish, particularly suitable for baking cakes, pizzas, roasting and timbales/puddings.

Warming oven/heating dishes

Bottom heating element.
Warming biscuits, tarts and savoury pies.
Heating dishes.

Browning oven

Top heating element.
Browning dishes, in particular, lasagne, and pasta and vegetable timbales.

Grill

Central top heating element.
Meat of small to medium thickness and toasting bread.

Fanned grill

Central top heating element + fan.
Meat of large thickness and dishes that are particularly voluminous.

Fan assisted oven

Top heating element + bottom heating element + fan.
Rapid and even cooking. Also recommended for biscuits and pastries.

Pizza/bread and rapid heat up

Circular heating element + bottom heating element + fan.
Reduced combination cooking times; the oven heats up in just few minutes. It is also ideal for cooking bread and pizza.

Fan assisted multilevel oven

Circular heating element + fan.
It allows for cooking similar or different dishes arranged on up to three shelves.

Defrost function

Rapid and optimal operation.
It is available with Touch Control multiprogram oven.

Keep warm function

It maintains a constant temperature of 80°C.
It is available with Touch Control multiprogram oven.

HOBS VISIBLE ESSENTIALITY

Decisive, essential, solid: the Unique hobs are a perfect example of the minimalist and vintage style of the line. The knobs, based on time-honoured Barazza models given a stylistic makeover, heighten the sensation of a passionate past with the result that the complete hob has a traditional yet innovative look.





UNIQUE HOBS GENERAL FEATURES

TRIPLE RING



Three flame rings that use at best the power provided by the flame in order to ensure rapid and even cooking.

CAST IRON PAN SUPPORTS



Made of cast iron, just like those used in professional kitchens, they are particularly solid, resistant to heat and therefore long-lasting. They improve the distribution and maintenance of heat. Special rubber tips ensure stability and prevent scratches to the surface.

EASY INSTALLATION

Barazza hobs consist of a single body that facilitates installation with tops; installation is also made easier owing to the fact that no gas regulation process is necessary; hobs operate both with methane gas and liquid gas.

AUTOMATIC IGNITION AND RAPID SAFETY VALVE



Turning on and regulating can be achieved in a single action using the knob. With all Barazza gas hobs, the spark plug is placed inside the burner, under the cover, away from liquids which may drip during cleaning operations. The rapid safety valve blocks the gas flow, even with the tap open, in case the flame accidentally goes out. It is activated when the burner is alighted and thanks to the rapid thermocouple, it takes just few seconds to function.

AIR INLETS

Barazza gas hob burners draw in the air necessary for combustion from above, therefore avoid the instance where unit/furniture apertures instigate air flow that may affect normal operation.

ECO-FLAME



Burners with steady flames and hotplates which provide high heat yields accompany Barazza gas hobs; they optimise energy consumption and reduce toxic substance emissions by more than 50% when compared to the details established by the Norms.

EXTRACTABLE ONE-PIECE BURNERS

Barazza gas hobs are equipped with easily extractable one-piece burners, greatly facilitating cleaning operations.

HOB STRUCTURE

With Unique hobs boasting completely level surfaces, infiltration is completely avoided.

CAST IRON WOK ADAPTER



It allows for the use of woks for frying, stewing, sautéing, braising or steam cooking. Optional on request. Suitable for triple rings.

LOWERED EDGE BUILT-IN (LEB)



The edge of Unique hobs rounds off with an oblique angle.



UNIQUE HOBS BUILT-IN

60 cm Unique built-in hob 3 gas burners + triple ring



Accessories: 35 36

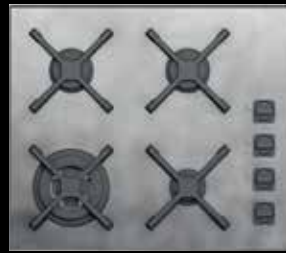

- AISI 304 extra thick stainless steel
- cast iron pan supports and burner caps
- 56x48 cm cut-out

Burners power:

- 1 auxiliary: 1 kW
- 2 semi-rapid: 1.75 kW
- 1 triple ring: 3.8 kW

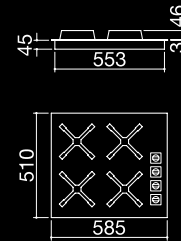

VINTAGE STAINLESS STEEL

code 1PUN64

UNIQUE HOBS BUILT-IN

100 cm Unique built-in hob 2 gas burners + 2 gas fish burners + triple ring

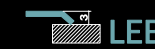

Accessories: 35 36

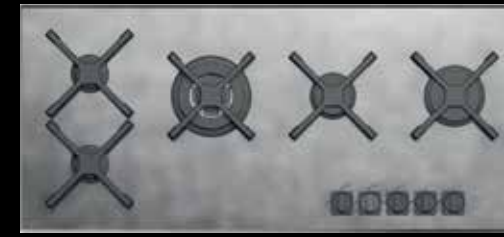

- AISI 304 extra thick stainless steel
- cast iron pan supports and burner caps
- 98x43 cm cut-out

Burners power:

- 2 auxiliaries: 1 kW
- 1 semi-rapid: 1.75 kW
- 1 rapid: 3 kW
- 1 triple ring: 3.8 kW

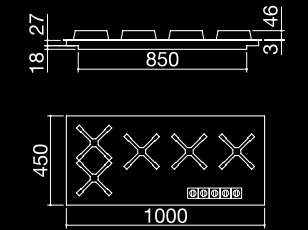

VINTAGE STAINLESS STEEL

code 1PUN105

70 cm Unique built-in hob 4 gas burners + triple ring



Accessories: 35 36

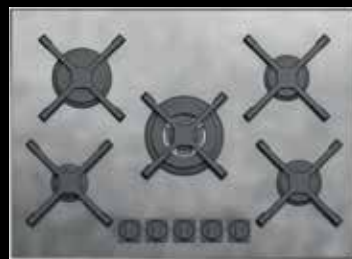

- AISI 304 extra thick stainless steel
- cast iron pan supports and burner caps
- 68x48 cm cut-out

Burners power:

- 1 auxiliary: 1 kW
- 2 semi-rapid: 1.75 kW
- 1 rapid: 3 kW
- 1 triple ring: 3.8 kW

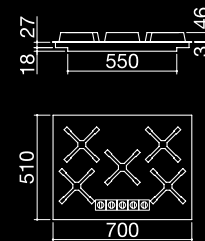

VINTAGE STAINLESS STEEL

code 1PUN75

90 cm Unique built-in hob 4 gas burners + triple ring



Accessories: 35 36



- AISI 304 extra thick stainless steel
- cast iron pan supports and burner caps
- 84x48 cm cut-out

Burners power:

- 1 auxiliary: 1 kW
- 2 semi-rapid: 1.75 kW
- 1 rapid: 3 kW
- 1 triple ring: 3.8 kW

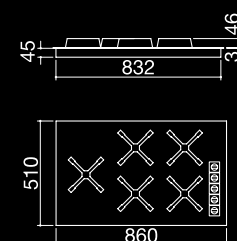

VINTAGE STAINLESS STEEL

code 1PUN95

Accessories



CAST IRON WOK ADAPTER

35
code 1RWJ



GAS PIPE

36
code 1TFL

Standard features: automatic ignition, safety valve, eco-flame, fixing clips, seal.

Unique features coordinate perfectly

Unique hobs and sinks coordinate perfectly thanks to the edge which is the same for both.



HOODS SOMETHING SMELLS GOOD

The high performance hoods in thick stainless steel are fitted with powerful, low-noise motors that help keeping the kitchen beautifully fragrant.





UNIQUE COOKER HOODS GENERAL FEATURES

STAINLESS STEEL



DESIGN STEEL FILTERS



The filters are made of AISI 304 stainless steel and stand out for their particular and refined design.

FILTERS SATURATION INDICATOR



A warning light and buzzer indicate when the filters are full.

LED LIGHTING



Unique Barazza cooker hoods are equipped with 3 or 4 LED spotlights (temperature 3000K). Long-lasting and efficient, they cut energy consumption.

ENGINE POWER



TELESCOPIC HOSE



The height of the hose can be adapted based on your specific requirements.

REMOTE CONTROL



The remote control, optional on request, lets you activate the LED spotlights and select the desired speed.

Advice for installation

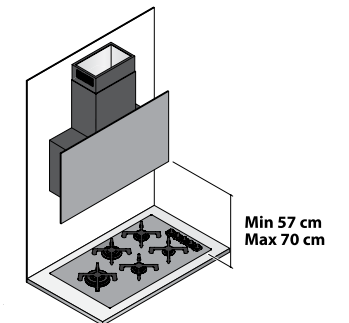



UNIQUE COOKER HOOD WALL

Unique wall cooker hood for 90 module

Energy rating **A** | Accessories: 41 42

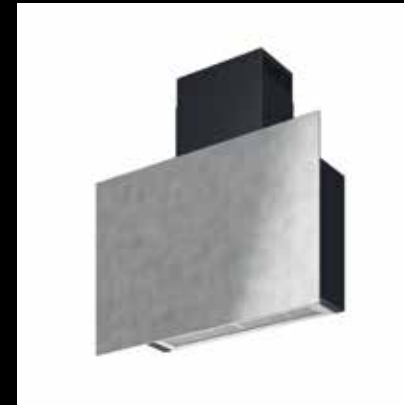

- AISI 304 stainless steel
- optional filter extraction
- speeds: 3 + intensive speed
- air-flow: 1000 m³/h
- pressure: 520 Pa
- noise level: 62 Lw(dBA)
- duct exit: ø 150 mm + ø 120 mm reducer
- lighting: LED spotlights (temperature: 3000K)
- stainless steel filters
- filters saturation indicator
- remote control: optional
- telescopic hose
- maximum absorbed power: 0.3 kW

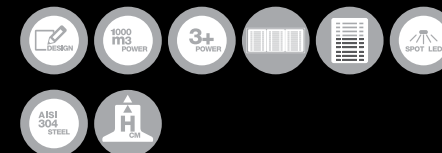
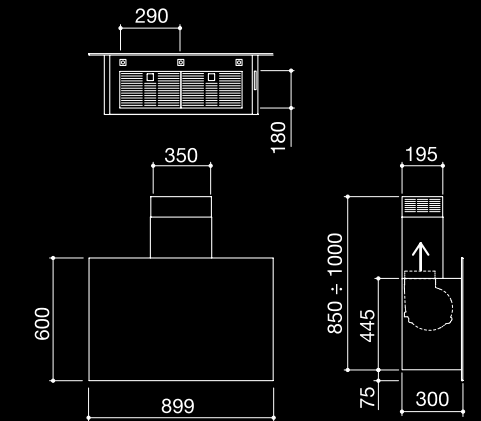

VINTAGE STAINLESS STEEL/BLACK

code 1KUNP9

wall cooker hood for 120 module

Energy rating **A** | Accessories: 41 42



- AISI 304 stainless steel
- optional filter extraction
- speeds: 3 + intensive speed
- air-flow: 1000 m³/h
- pressure: 520 Pa
- noise level: 62 Lw(dBA)
- duct exit: ø 150 mm + ø 120 mm reducer
- lighting: LED spotlights (temperature: 3000K)
- stainless steel filters
- filters saturation indicator
- remote control: optional
- telescopic hose
- maximum absorbed power: 0.3 kW

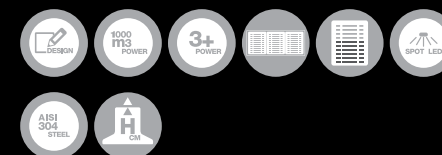
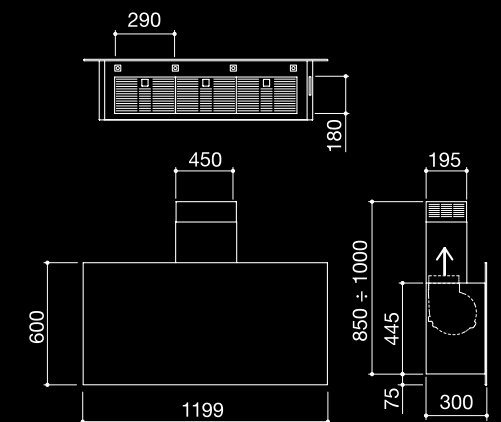

VINTAGE STAINLESS STEEL/BLACK

code 1KUNP12

Accessories

CARBON FILTER



41
code 1FC1

REMOTE CONTROL



42
code 1RC

SINKS WHERE EVERYTHING RUNS SMOOTHLY

Sinks with highly appealing lines, featuring steel that has undergone distinctive treatment and an ergonomic design for unhindered movements and easy handling of tableware. Available in two-bowl or single-bowl versions, the latter in two different sizes.



UNIQUE SINKS GENERAL FEATURES AND OPTIONAL ELEMENTS

EXTRA THICK STAINLESS STEEL

 Barazza sinks use extra thick AISI 304 stainless steel that is completely recyclable, resistant to corrosion, does not degrade over time and is extremely hygienic.

SPACE-SAVER TRAP

Reduced size trap allows easier use of the space under the sink.

PERIMETER OVERFLOW

 This device is a safety factor when taps are left on, with perimeter overflow.

CAPACIOUS BOWLS

 Unique sinks have capacious bowls that can hold pans and large utensils.

POP-UP PLUG

 It allows you to empty the bowl without having to place your hands inside the bowl. Useful for avoiding splashing or burning yourself, in case the water is hot.

BOWL WITH RADIUS "15"

 Unique sinks are available with radius "15" bowls which make them easy to clean, without compromising on design.

LOWERED EDGE BUILT-IN (LEB)



The edge of Unique sinks rounds off with an oblique angle.

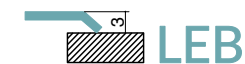

ROUND BASKET STRAINER WASTE WITH DRAIN COVER

 Barazza basket strainer waste plugs are approved by LGA that certifies 100% conformity with Norm EN274. Stronger, thanks to the increased thickness of the stainless steel and plastic materials, they are equipped with seals that ensure the water remains in the bowl, always acting 100% in compliance with the Norm, even in case of a dirty bowl. Maximum water-tightness even in the joining between the trap and the basket strainer waste plug, whose screw, in order to avoid deformation of plastic components owing to thermal shock, is protected by a brass bushing. The 3" 1/2 basket strainer waste allows the Barazza waste disposers to be used (compatibility with other manufacturers' waste disposers is not guaranteed). The stainless steel drain cover adds an extra touch of elegance to the sink.

RECTANGULAR POLYETHYLENE CHOPPING BOARD

Practical chopping board in white polyethylene, available in 20x43 cm and 26x43 cm.



GLASS BOWL COVER

The elegant 30x43 cm bowl cover in glass adds greater functionality to the sink area.



STAINLESS STEEL COLANDER WITH DRAINING-RACK

The stainless steel colander with draining-rack can be used for washing and draining plates, glasses and cutlery. It can also be used as a handy surface for resting utensils on. Size: 25x43 cm.



STAINLESS STEEL COLANDER BOWL

Multi-purpose colander bowl useful for cleaning, washing and draining. Size: 15x43 cm.



RECTANGULAR STAINLESS STEEL BOWL COVER WITH BLACK CHOPPING BOARD

The slotted stainless steel shelf features a practical sliding chopping board in black HPL. Together they create a handy, multi-functional space for chopping, rinsing, draining or storing. The bowl cover is also available without the chopping board. Size: 25x43 cm.



UNIQUE SINKS BUILT-IN

58x51 cm Unique built-in sink
1 bowl



Accessories: 7 8 17 20 25 39 40



- bowl with radius "15"
- AISI 304 extra thick stainless steel
- 50x40x20 h cm bowl
- equipment: 3" ½ basket strainer waste, pop-up plug, stainless steel drain cover, perimeter overflow
- mixer tap hole: 2 standard holes
- 60 cm base unit for bowl
- 56x49 cm cut-out

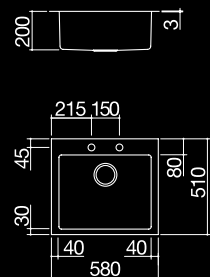

VINTAGE STAINLESS STEEL

code 1LUN61

UNIQUE SINKS OPTIONAL ELEMENTS

Accessories

20X43 CM POLYETHYLENE CHOPPING BOARD



26X43 CM POLYETHYLENE CHOPPING BOARD



STAINLESS STEEL COLANDER BOWL



STAINLESS STEEL COLANDER WITH DRAINING-RACK



RECTANGULAR STAINLESS STEEL BOWL COVER



GLASS BOWL COVER



RECTANGULAR STAINLESS STEEL BOWL COVER WITH BLACK CHOPPING BOARD



The stainless steel sink accessories are available with the satin finish only.

Standard features: fixing clips, seal, space-saver trap with dishwasher connection, cardboard packaging. The mixer tap is not included.

79x51 cm Unique built-in sink
1 bowl



Accessories: 7 8 17 20 25 39 40



- bowl with radius "15"
- AISI 304 extra thick stainless steel
- 71x40x20 h cm bowl
- equipment: 3" ½ basket strainer waste, pop-up plug, stainless steel drain cover, perimeter overflow
- mixer tap hole: 2 standard holes
- 80 cm base unit for bowl
- 77x49 cm cut-out

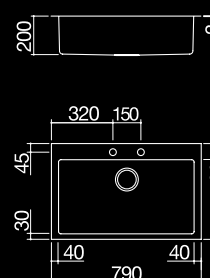

VINTAGE STAINLESS STEEL

code 1LUN81

2 bowls



Accessories: 7 8 17 20 25 39 40



- bowls with radius "15"
- AISI 304 extra thick stainless steel
- 34x40x20 h cm bowl
- equipment: 3" ½ basket strainer waste, pop-up plug, stainless steel drain cover, perimeter overflow
- mixer tap hole: 2 standard holes
- 80 cm base unit for bowls
- 77x49 cm cut-out

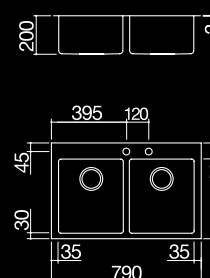

VINTAGE STAINLESS STEEL

code 1LUN82



TAPS ESSENTIAL, UNIQUE, INCOMPARABLE. LIKE WATER

Whether with round or square section, with or without pull-out shower head, they all have a single-control mixer tap and an original matt black finish. A combination of practicality and good looks perfectly in line with the Barazza style.





UNIQUE SINGLE LEVER MIXER TAPS

Unique One mixer tap



- ceramic disc cartridge
- tap rotation: 360°
- tap base: 50x50 mm
- tap hole: ø 35 mm

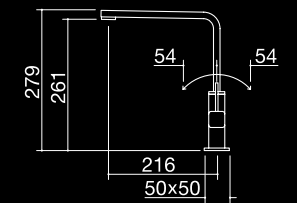

BLACK

code 1RUBUN1

Unique Two mixer tap



- ceramic disc cartridge
- tap rotation: 360°
- tap base: ø 50 mm
- tap hole: ø 35 mm

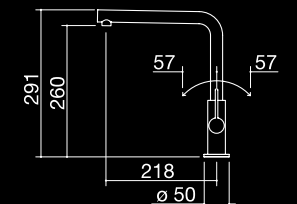

BLACK

code 1RUBUN2

Unique Two shower mixer tap



- pull out spray head
- ceramic disc cartridge
- tap rotation: 360°
- tap base: ø 50 mm
- tap hole: ø 35 mm

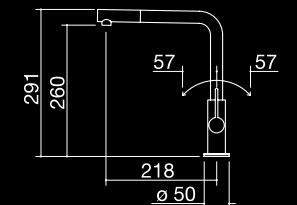

BLACK

code 1RUBUN2D

Unique Two shower mixer tap



ACCESSORISED CHANNELS SYNERGIC ELEGANCE

There's a place for everything you need at your fingertips. The accessorised channels give that final touch of efficiency and practicality to the worktop, offering a place for everything within easy reach of the sink and the hob.





ACCESSORISED CHANNELS ELEMENTS

POWER SOCKET HOLDER



This technological solution provides sockets just where you need them. The practical 180° rotation mechanism means that the sockets can be hidden under an elegant stainless steel cover.

CHOPPING BOARD HOLDER



It holds a set of three chopping boards in black HPL, a resistant material that continues to perform over time. Two chopping boards can easily be joined together, to create an even more practical and versatile space to work on.

KNIFE BLOCK



The black HPL knife block that holds twelve knives ensures you always have the knives you need available when preparing different dishes, and allows them to drip dry after washing.

DRAINING-RACK



Elegant rack in stainless steel for storing or draining plates.



#1 GLASS DRAINER

This drainer top is useful for resting glasses or small utensils you need while cooking on, or for draining after washing. Available as a 1-unit or 1/2-unit element.

#2 BOTTLE HOLDER

This multi-functional element can be used as a practical storage spot for bottles, ladles, cutlery or kitchen herbs.

#3 COLANDER

This practical colander adds a flexible element to the accessorised channel, providing a multi-purpose storage container for the things you need close to the sink or hob such as sponges, detergents, spices, cutlery and glasses.

SATIN STAINLESS STEEL ACCESSORISED CHANNELS FLUSH AND BUILT-IN

ACCESSORISED CHANNELS MODULAR ELEMENTS

90 cm built-in and flush channel



FEB FT

- 2" basket strainer waste bowl
- space for 3 units
- AISI 304 extra thick stainless steel
- 84x16 cm cut-out flush: see website
- 90 cm base unit

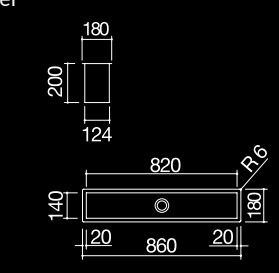

SATIN STAINLESS STEEL code 1CI90

120 cm built-in and flush channel



FEB FT

- 2" basket strainer waste bowl
- space for 4 units
- AISI 304 extra thick stainless steel
- 111.5x16 cm cut-out flush: see website
- 120 cm base unit

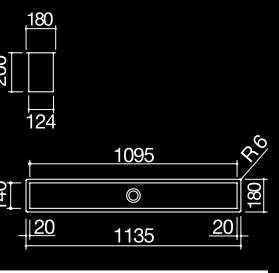

SATIN STAINLESS STEEL code 1CI120

180 cm built-in channel



- 2" basket strainer waste bowl
- space for 6 units
- AISI 304 extra thick stainless steel
- wall fixing supports
- 10x13.8 cm mobile drainer supplied
- 178x18 cm cut-out; 178x19 cm wall

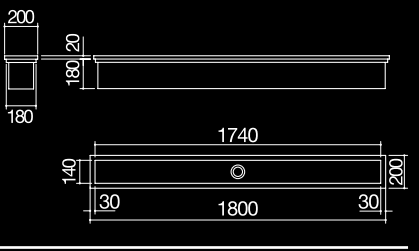

SATIN STAINLESS STEEL code 1CIA180

FEB FT



The accessorised channels and stainless steel accessories that fit inside them are available with the satin finish only.

Standard features: fixing clips, 2" basket strainer waste plug.

Rotating socket holder



- AISI 304 extra thick stainless steel cover
- 2 Schuko sockets
- 1 USB socket for electronic devices
- cover with 180° rotation mechanism

The socket holder must be positioned at the ends of the 90 cm and 120 cm channels, or, for the 180 cm channel, at the ends or in the centre.

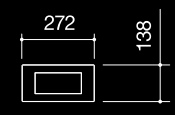

1-unit element
SATIN STAINLESS STEEL code 1CPP

Chopping board holder



- AISI 304 extra thick stainless steel
- 3 black HPL chopping boards
- chopping board with magnetic mechanism

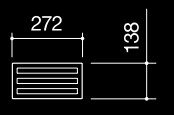

1-unit element
SATIN STAINLESS STEEL/BLACK code 1CPT

Draining-rack



- AISI 304 extra thick stainless steel
- for 3 dinner plates or soup bowls

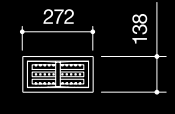

1-unit element
SATIN STAINLESS STEEL code 1CSP

Knife block



- black HPL
- for up to 12 knives

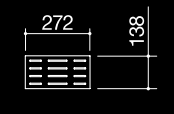

1-unit element
BLACK code 1CPC

Colander



- AISI 304 extra thick stainless steel



1-unit element
SATIN STAINLESS STEEL code 1CVS

Large glass drainer



- AISI 304 extra thick stainless steel



1-unit element
SATIN STAINLESS STEEL code 1CRG

Bottle holder



- black HPL shelf
- AISI 304 stainless steel



½-unit element
SATIN STAINLESS STEEL/BLACK code 1CPB

Small glass drainer



- AISI 304 extra thick stainless steel



½-unit element
SATIN STAINLESS STEEL code 1CRP

ACCESSORISED CHANNELS COMPOSITIONS

The composition system is based on three types of accessorised channels, designed to house three units (90 cm channel), four units (120 cm channel) or six units (180 cm channel). Six 1-unit elements (272x138 mm) and two ½-unit elements (136x138 mm) are available.

MIX AND MATCH

Mix and match the elements you like best.

PRACTICAL AND FUNCTIONAL

The elements can be chosen to create solutions for washing and cooking areas, or to suit your specific needs.

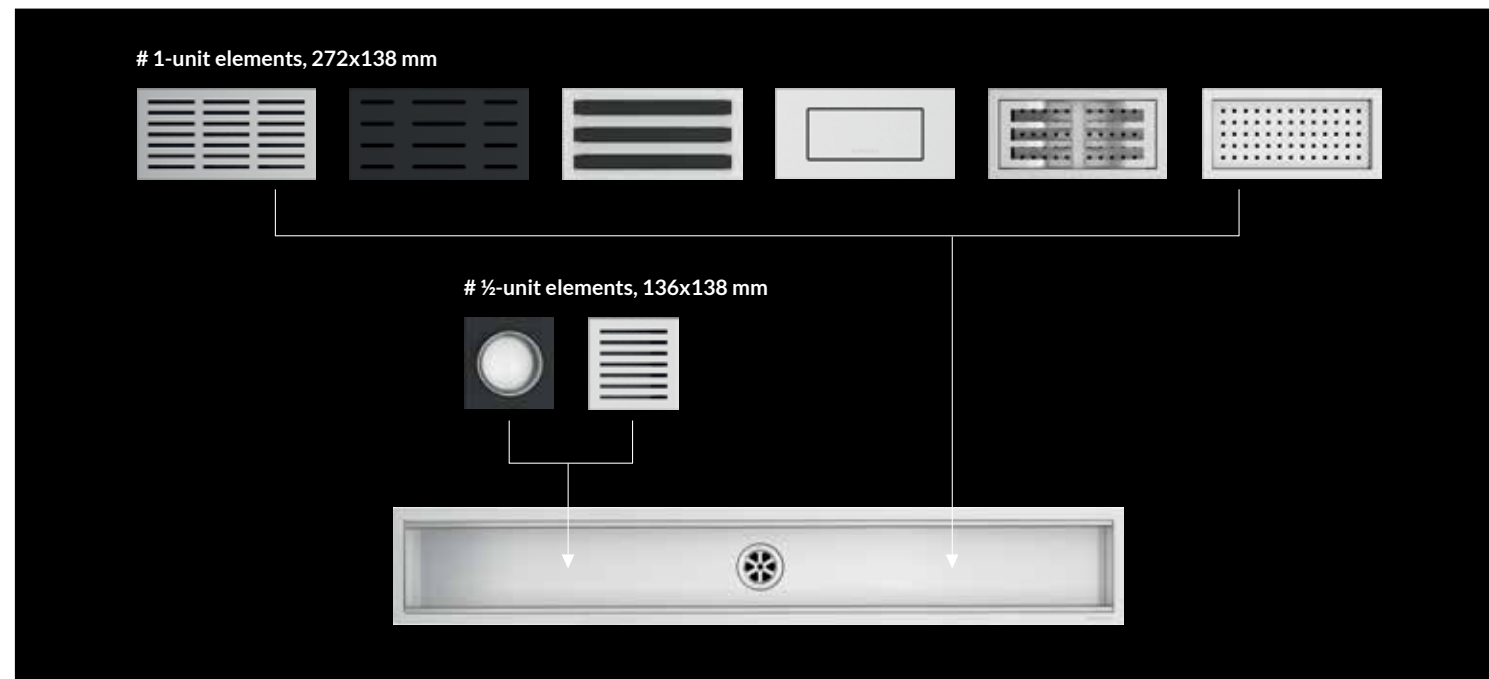

Examples of accessorised channels



- 90 cm built-in and flush accessorised channel with three 1-unit elements.



- 90 cm built-in and flush accessorised channel with two 1-unit elements and two ½-unit elements.



- 120 cm built-in and flush accessorised channel with four 1-unit elements.



- 120 cm built-in and flush accessorised channels with three 1-unit elements and two ½-unit elements.



- 180 cm built-in accessorised channel with six 1-unit elements and one mobile drainer (standard supply).



- 180 cm built-in accessorised channel with four 1-unit elements, four ½-unit elements and a mobile drainer (standard supply).

ACCESSORISED CHANNELS MATERIALS



The elements which make up the Barazza accessorised channels are created using two types of material:

- Satin AISI 304 stainless steel with a high chromium and nickel content; it is completely recyclable, hygienic, free of toxic emissions and does not disintegrate over time as it is resistant to corrosion.
 - Black HPL, extremely hygienic and highly resistant to scuffs, knocks, scrapes, chemical agents and heat.
- Both are robust, refined and made to last, and they also provide a strong visual contrast. By putting these extremely different materials side by side, you can create elegant steel/black compositions, as well as “all steel” options, according to the furnishings as well as tastes and preferences of those spending time in the kitchen.



SPOTLESS,
FEARLESS

CLEANING PRODUCTS

EASY CLEAN CLEANING CREAM

EASY CLEAN is a cleaning cream developed exclusively for cleaning sinks, hobs, cooker hoods, ovens and stainless steel surfaces in general. Formulated with top-quality ingredients, it is rich in polishing pigments and conditioning substances. It treats stainless steel gently, effortlessly removing limescale and grease stains. Used periodically or as necessary, it restores lustre to the surface and forms a protective shield that delays tarnished appearance or dirt deposits.

EASY CLEAN MICROFIBRE CLOTH

Barazza professional EASY CLEAN microfibre cloth is degreaser and absorbent and removes all types of stains from any stainless steel surface and not, without leaving streaks and lint, without the use of chemical detergents. The innovative product is characterized by an extraordinary softness and durability that make it indispensable for every-day cleaning.

Easy Clean cleaning cream



- professional stainless steel cleaning cream
- cleans, polishes and protects stainless steel
- contents 250 ml each

3 bottles

code 1EC3

12 bottles

code 1EC12

Easy Clean microfibre cloth



- professional microfibre cloth for everyday stainless steel cleaning
- degreasing and absorbent action without the use of chemical detergents
- size: 46x50 cm

3 clothes

code 1PI3

STAINLESS STEEL

Stainless steel has a high level of chromium and nickel and is resistant to rusting and staining. There are different types of stainless steel; Barazza products are made of AISI 304 stainless steel (U.S. mark: American Iron and Steel Institute), containing 18% of chromium and 10% of nickel, that give steel its anti-corrosive and antibacterial properties.

For a perfect maintenance Barazza recommends:

- # To rinse well with water after use and to dry with a clean cloth or a chamois leather cloth.
- # Not to use detergents containing chlorine and its by-products, as muriatic acid or bleach.
- # It is suggested to use a little warm white vinegar, only for persistent stains.
- # Not to use steel wool or abrasive materials, that would irreparably scratch the surface.
- # Not to drag objects on the top. To use chopping boards and mats while working in the kitchen.
- # Not to place hot pans and ovens on the top in order to avoid buckling and blueing.
- # Not to leave rusty metal objects on the surface for a long time.
- # Not to leave open packets or bottles of detergents or other chemical substances near the product.

DOORS AND DRAWERS THE BESPOKE ASPECT OF UNIQUE



VINTAGE STEEL MADE TO MEASURE DESIGN



Stainless steel with a vintage finish can also be used for custom doors, drawers, worktops, upstands, splashbacks, side panels and shelves. Barazza is in a position to bring together artisan skill and advanced technology to satisfy requests for made to measure finishes and provide solutions to meet the needs of those people spending time in the kitchen. All of this is finished off with Barazza distinctive manually worked steel that transforms every unit into a one-off piece of special furniture. Passion for creativity and beauty blends with the possibility to customize the kitchen, to suit any style, space, colour and ambiance – to create a truly Unique effect.

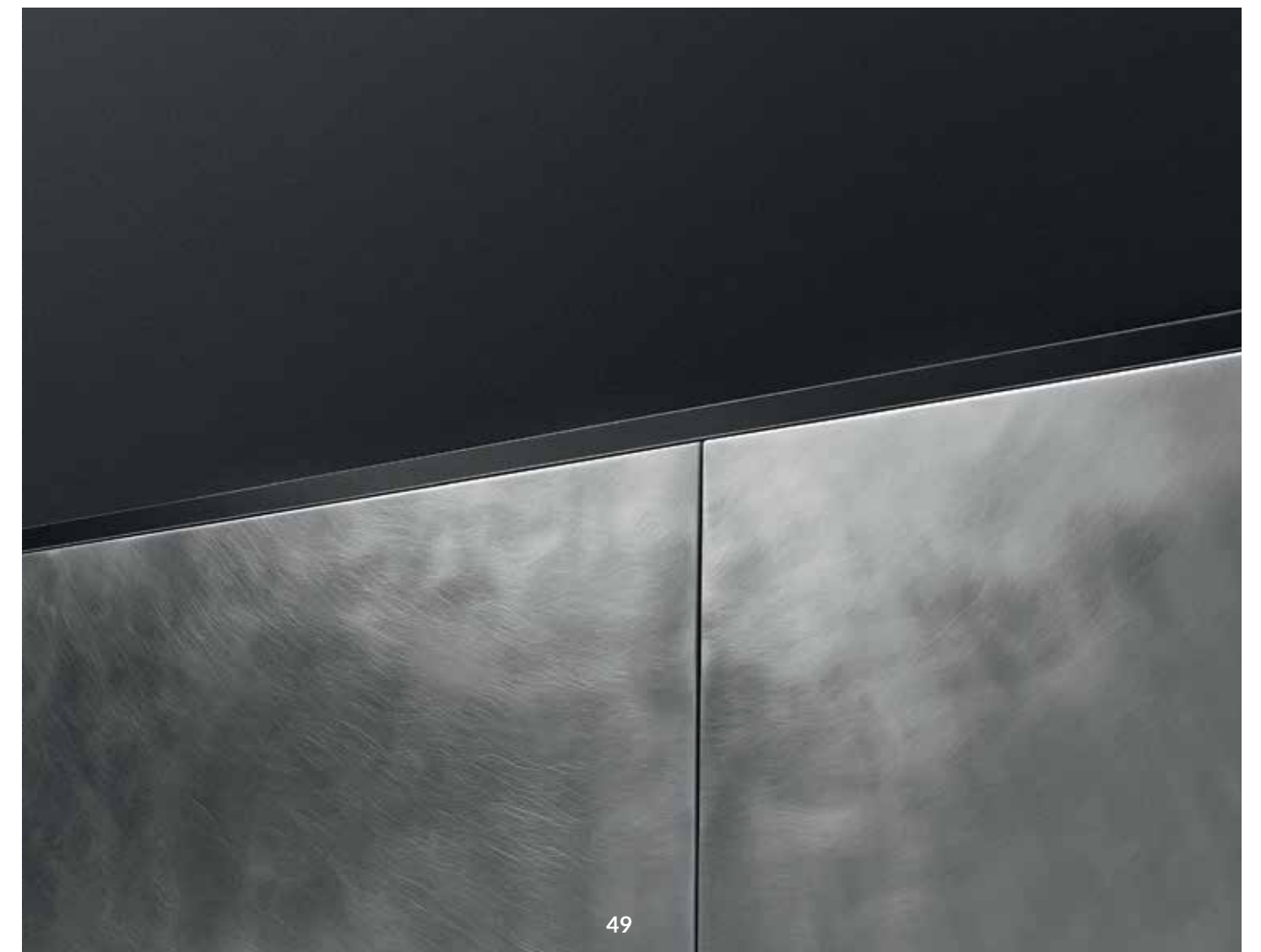

VINTAGE STEEL, ARTISAN CRAFT UNIQUELY HANDMADE



There is no piece like another. Here the beauty lies in chance, which brings original twists and turns to every piece to create new effects according to the different inputs. Every piece in vintage steel is unique, inimitable, just for you. This is the added value of a handcrafted piece: quirky features, skilful craftsmanship and knowing you have a one-off.

ICONS LEGEND

OVENS

- TELESCOPIC OVEN RAILS
- DESIGN
- MANUAL COOKING FUNCTIONS
- AUTOMATIC COOKING PROGRAMMES
- TOUCH CONTROL PROGRAMMER
- OVEN CAPACITY
- EASY-CLEAN OVEN LINING
- TANGENTIAL COOLING FAN
- COOL DOOR
- CHILD SAFETY LOCK

HOBS

- MODULE
- DESIGN
- TRIPLE RING
- BURNERS IN LINE
- CAST IRON PAN SUPPORTS
- AUTOMATIC IGNITION AND SAFETY VALVE
- ECO-FLAME

COOKER HOODS

- AISI 304 STAINLESS STEEL
- DESIGN
- 1000 m³/h ENGINE
- 3 SPEEDS + INTENSIVE
- AISI 304 STAINLESS STEEL FILTERS
- FILTERS SATURATION INDICATOR
- LED LIGHTING
- TELESCOPIC HOSE
- REMOTE CONTROL

SINKS

- AISI 304 EXTRA THICK STAINLESS STEEL
- DESIGN
- CAPACIOUS BOWLS
- STAINLESS STEEL DRAIN COVER
- PERIMETER OVERFLOW
- POP-UP PLUG
- BOWL RADIUS

TAPS

- 360° TAP ROTATION
- PULL OUT SPRAY HEAD

INSTALLATIONS

- LOWERED EDGE BUILT-IN (LEB)
- FLUSH (FT)
- FLAT EDGE BUILT-IN (FEB)

WEIGHTS AND VOLUMES SEARCH FOR CODE

Code	Page	Packaging size (cm)	Volume (m ³)	Weight (kg)	Code	Page	Packaging size (cm)	Volume (m ³)	Weight (kg)
1FUNMV	14	64x64x67.5	0.28	40.9	1CI90	42	20x25x100	0.05	6
1FUNPV	15	64x64x67.5	0.28	38.3	1CI120	42	20x25x126	0.06	8
1PUN64	20	65x57x16.5	0.06	17.5	1CIA180	42	24x27x190	0.12	14
1PUN75	20	77x57x16.5	0.07	20.9	1CRG	43	31x17x4	0.003	2
1PUN95	20	92x57x16.5	0.08	26	1CPT	43	31x23x12	0.008	7
1PUN105	21	106x52x16.5	0.09	25.7	1CSP	43	31x23x12	0.008	3
1KUNP9	27	95x68x51	0.33	28	1CPC	43	31x17x4	0.003	2
1KUNP12	27	125x68x51	0.43	32	1CPP	43	31x23x12	0.008	5
1LUN61	32	62,5x55x28	0.08	8	1CVS	43	31x23x12	0.008	2
1LUN81	32	89,5x55x28	0.14	10.5	1CRP	43	31x17x4	0.003	1.5
1LUN82	32	89,5x55x28	0.14	10.5	1CPB	43	31x23x12	0.008	2

TECHNICAL ASSISTANCE

SALES POINTS

For the up-to-date list of authorised distributors, go to www.barazzasrl.it.

INFORMATION SERVICE

Barazza has an Information Service to help you quickly with anything concerning:

- information about products and accessories
- solutions to problems
- instruction handbooks
- information about installation procedures

TO CONTACT THE INFORMATION SERVICE DIRECTLY:

phone: +39 0438 62888
fax: +39 0438 64901
e-mail: info@barazzasrl.it

RESERVED AREA

By entering your personal key codes, you can access Barazza's reserved area where you can consult all the online documentation, Lab and B_Free Fusion configurators and the interactive Made-to-measure price catalogue.

GENERAL NOTES

Barazza reserves the right to make any change, at any time and without notice, in order to improve its products. The colours provided are used purely by way of example.

Reproduction of this catalogue, even in parts, for commercial purposes without specific authorisation from Barazza, is strictly forbidden.

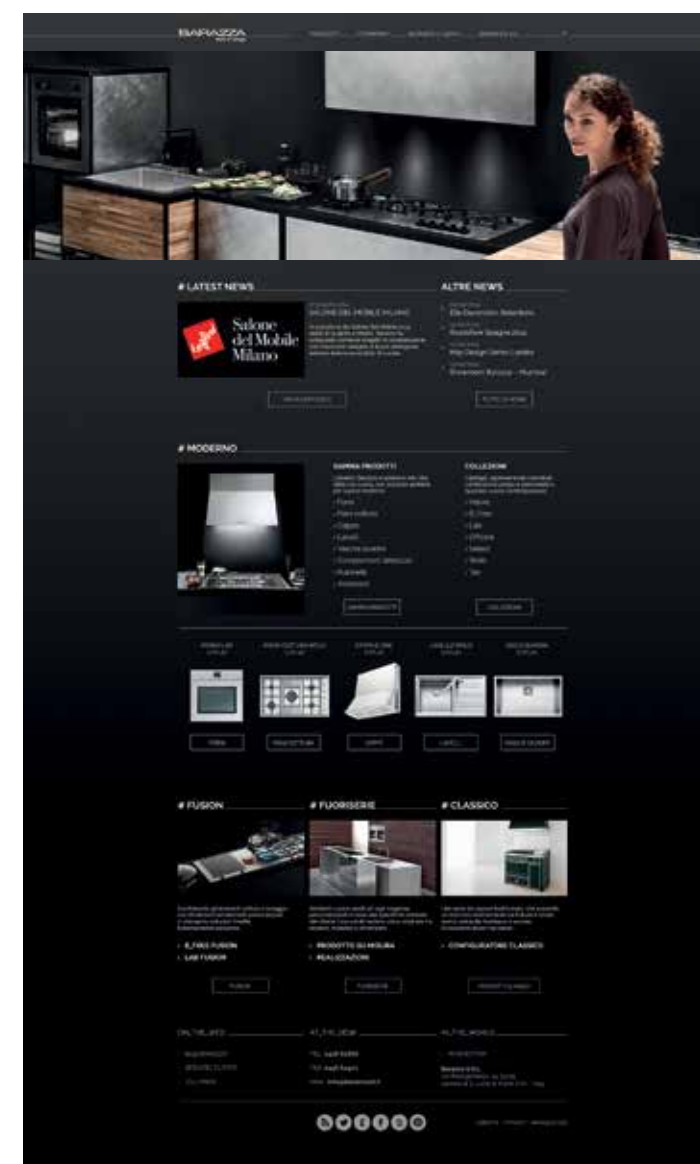

CERTIFICATIONS



Barazza is certified according to UNI EN ISO 9001 and 14001 standards. UNI EN ISO 9001 certification guarantees quality control and optimisation of production processes, placing customer satisfaction as the main priority.



Barazza also complies with the UNI EN ISO 14001 standard, with the aim of maintaining and improving the managing of environmental impacts of its activities, optimizing energy and natural resources and implementing control systems for waste disposal and prevention of pollution.

Art Direction: Claim.Brandindustry
Photography: Varianti
Lithography: Varianti
Paper: Gardamatt 200 g/mq
Cover: Fedrigoni Woodstock Black 285 g/mq
Printed in Italy: Grafiche Antiga - 03.2016



BARAZZA
taste of design