

BATH

COLLECTION



MGS
MILANO

BATH

COLLECTION



Solid stainless steel eco-friendly faucets for the kitchen, bath and outdoor
Rubinetti in acciaio inossidabile massiccio per cucina, bagno ed esterni

ENGINEERED IN SWITZERLAND - MADE IN ITALY

THE IDEA



It was 1997 when Marcello, Giulio and Stephen met on the shores of Lake Maggiore, in Northern Italy at the foot of the Alps. Marcello, a visionary Italian entrepreneur; Giulio, an ingenious industrial designer and Stephen, a dedicated Swiss manager.

Giulio proposed to his friend Marcello to enter the flourishing plumbing industry. In fact, the area surrounding Lake Maggiore is famous for its tourism, history and natural beauty, but what most do not know is that it is also a well developed industrial area that specializes in the faucet industry and, more importantly, in the stainless steel industry.

Giulio, at the time, was already collaborating with local manufacturers of plumbing products therefore he was familiar with the related technical aspects and he also had a vast know-how in the field of metals. The idea was appealing to Marcello, but his passion for unique and eco-friendly products did not permit him to take the easy path. He wanted to create something that would be different: it had to be “the best” product available in the market and it had to be eco-friendly.

The idea of using solid stainless steel was born.

At the time, stainless steel was used for industrial faucets but it was considered too costly and hard to use for domestic taps. Nevertheless MGS selected it because of its numerous advantages and hence extensive research and development began. Once it was decided to move forward with the innovative material, specific technical knowledge, experienced artisans and specialized machinery were required: the local long lasting tradition and proficiency in manufacturing of stainless steel products was fundamental.

Finally, more than a year later, the first stainless steel faucet for domestic use was produced: the Unico. Thanks to Giulio's talent and to Stephen's management, Marcello's idea was an immediate success: many tap manufacturers immediately recognized it as being “the best” faucet in the world.

Since then the product range has been greatly developed. An ample selection of kitchen faucets and accessories and four bath collections were added. Keeping in mind the needs of the consumers, architects and designers, new products are constantly being developed. Just like in the very beginning, we continue to strive to manufacture unique products with excellent quality standards, extreme attention to ecology, details, tolerances and finish.

LA NASCITA DI UN'IDEA

Sul finire del 1997 Marcello, Giulio e Stephen si incontrarono sulle rive del Lago Maggiore per discutere di nuove opportunità industriali. Marcello, un imprenditore; Giulio, un talentuoso progettista; Stephen, un manager svizzero.

Giulio, già pratico del settore, propose all'amico Marcello di investire nella produzione di rubinetti: industrie ferventi nella zona del lago altrimenti universalmente noto per le sue isole, la lussureggiante vegetazione, la bellezza del paesaggio e le dimore principesche. Invogliato, Marcello si informò sul materiale e sulle fasi di lavorazione concludendo di non essere interessato a investire in una produzione in ottone cromato, inquinante e rischiosa per la salute e per l'ambiente: nacque così l'idea di produrre, primi al mondo, rubinetti in acciaio inossidabile per uso domestico.

All'epoca l'acciaio inossidabile era adoperato nella produzione di rubinetteria ad uso industriale, mai nel domestico.

Un anno di ricerca e sviluppo permise di mettere a punto UNICO: il primo rubinetto in acciaio inossidabile per cucina. L'innovazione raccolse il plauso del mercato in un periodo in cui incominciava già a manifestarsi un forte interesse per l'ecologia: in molti asserirono che UNICO era il più bel rubinetto al mondo.

Negli anni successivi la gamma è stata ampliata con l'aggiunta di nuovi modelli per cucina e bagno, rispettando la filosofia iniziale di altissima qualità, grande precisione, tolleranze infinitesimali, rispetto dell'ambiente e finiture impeccabili.



PENTA

COLLECTION

Design by ErvasBasilicoGirardi

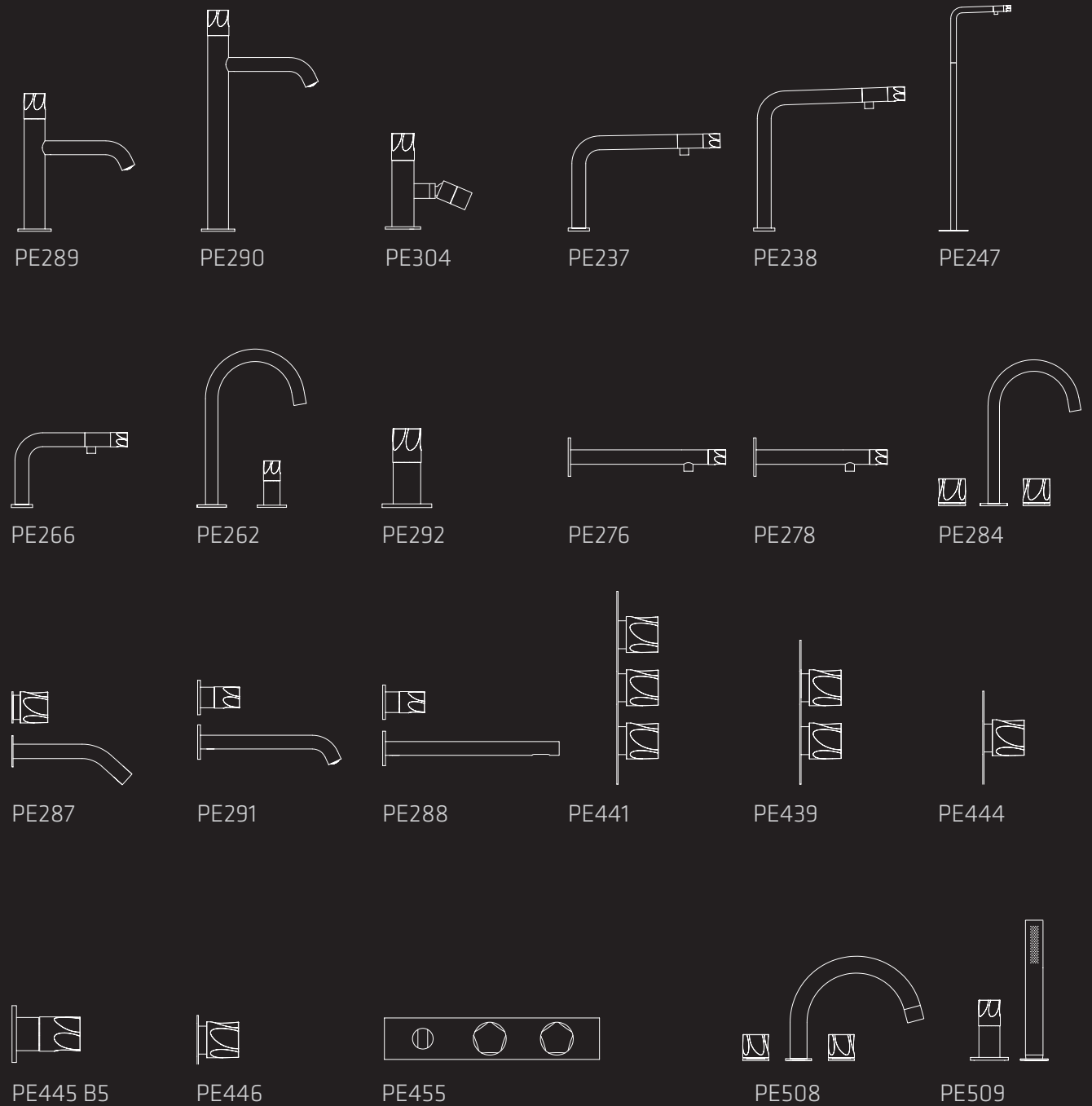

Stainless steel itself seems to soften into a twisting motion, resulting in five concave facets that form a pentagon. An attractively ergonomic shape that you will enjoy grasping and using daily. Penta - an elegant and timeless collection.

L'acciaio stesso sembra ammorbidirsi e torcersi creando 5 sfaccettature concave, che a loro volta formano un pentagono. Ergonomia, eleganza del design e matericità dell'acciaio rendono Penta una linea senza tempo, al di fuori da mode e tendenze.



PE|289



YELLOW GOLD - ORO GIALLO



TITANIUM - TITANIO



PE289



PE290



PE304



PE|238



PE237

PE238

PE247

PE266

PE|262



PE262



PE292

PE|278



PE276



PE278

PE|284



PE284



PE287





PE|291



PE291



PE288



PE|440



Thermostatic shower valves
with volume controls:

- PE439 : single way volume control
- PE440 : controls two water outlets
- PE449 : controls three water outlets
- PE441 : controls two water outlets
- PE442 : controls three water outlets
- PE443 : controls four water outlets

Valvole doccia termostatiche
con rubinetti di chiusura:

- PE439 : controlla una uscita acqua
- PE440 : controlla due uscite acqua
- PE449 : controlla tre uscite acqua
- PE441 : controlla due uscite acqua
- PE442 : controlla tre uscite acqua
- PE443 : controlla quattro uscite acqua



PE441 / PE442 /
PE443



PE439/PE440/
PE449



PE446/PE704



PE444

PE|455



Horizontal thermostatic valve with hand shower support
Miscelatore termostatico orizzontale con supporto per doccia

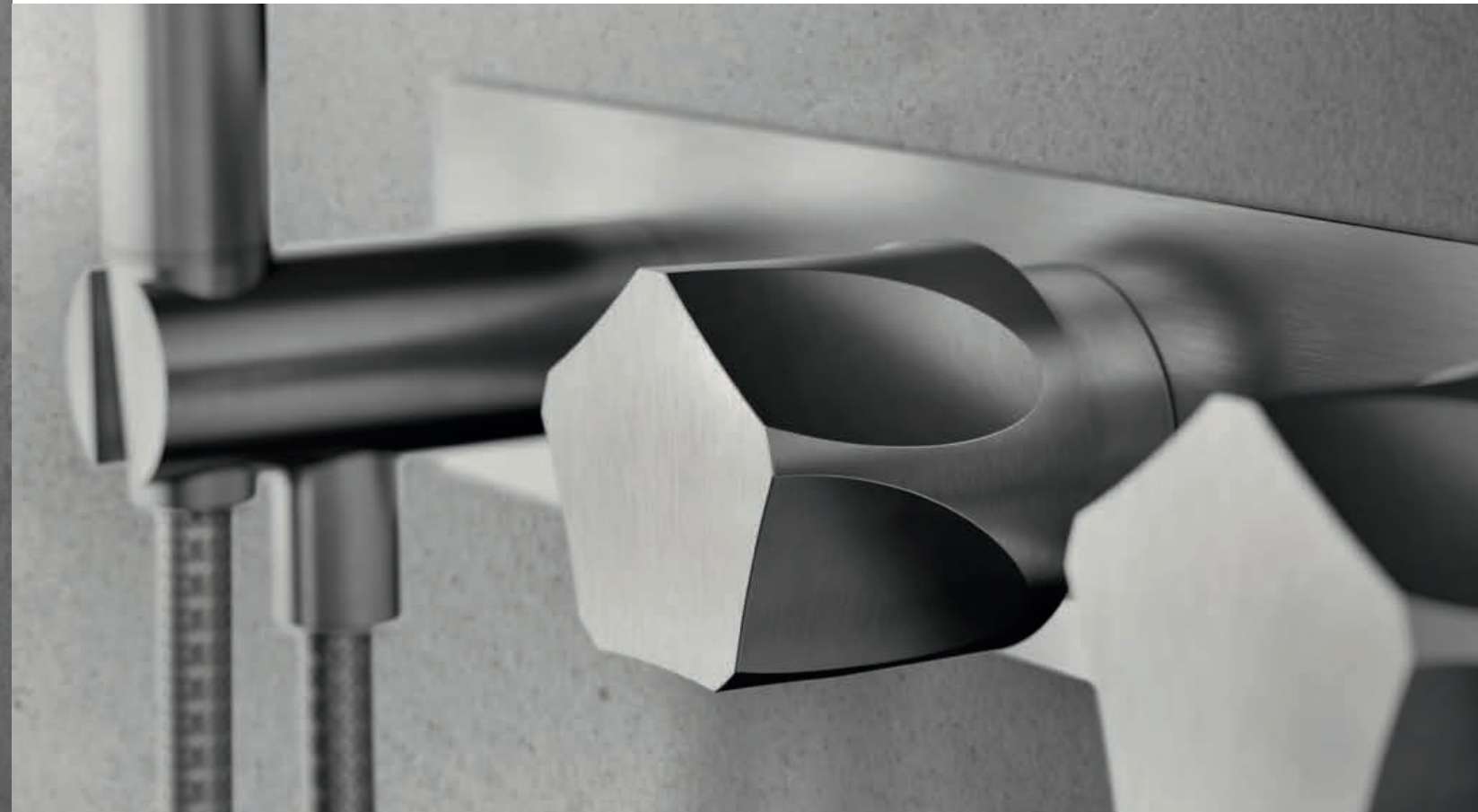

PE445 B5



PE455



PE456

Two ways, controls the hand shower plus a second water outlet
Due vie, controlla la doccia più una seconda uscita acqua

Three ways, controls the hand shower plus two additional water outlets
Tre vie, controlla la doccia più due uscite acqua

PE|508 + PE|509



PE508



PE509

CON TEMP ORARY

COLLECTION

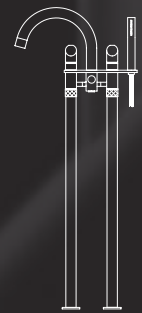

CB502

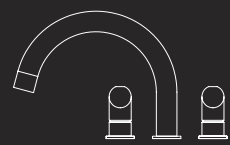

CB513

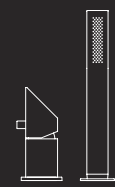

CB514

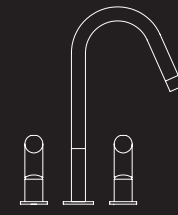

CB200

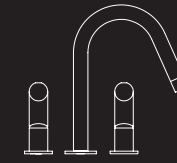

CB201



CB202



CB203

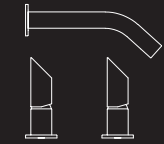

CB211

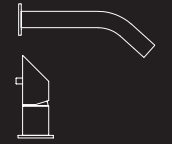

CB214

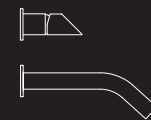

CB215



CB217



CB218



CB219



CB220

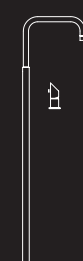

CB221



CB222

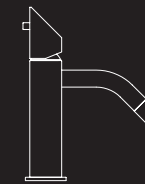

CB227



CB228

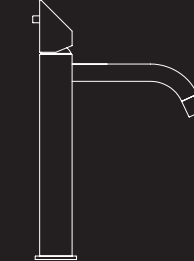

CB229

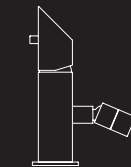

CB303

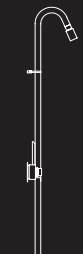

CB401



CB402



CB404

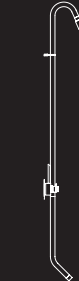

CB447

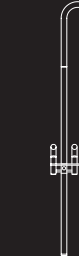

CB400



CB406



CB431

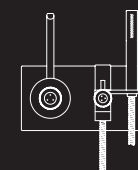

CB432



CB436

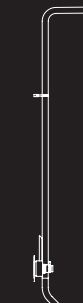

CB437



CB438



CB448

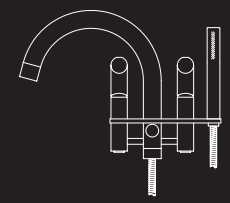

CB501



CB|200

Handles tilt forward to open
Le leve basculanti controllano il flusso



CB200



CB201



CB202



CB203



CB|215

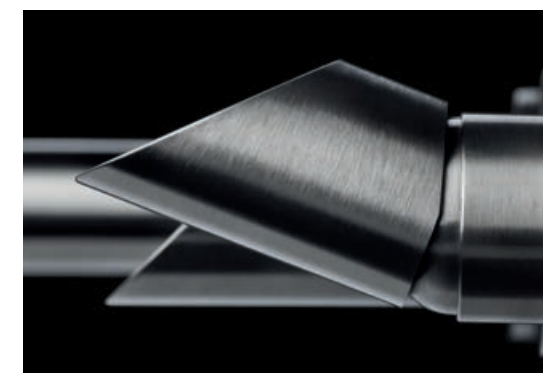

Lavatory wall mounted spout offering maximum installation flexibility
Canna da muro con massima flessibilità di installazione



CB211

CB214

CB215



CB|221



CB217



CB218



CB219



CB220



CB221



CB222

CB|227



The Contemporary collection is characterized by 45° angles
La collezione Contemporary è caratterizzata da tagli a 45°



CB227



CB228



CB229



CB303

CB|402



CB401



CB402



CB404



CB447

Available with hand shower,
or bathtub filler or footwash
Disponibile con doccia a mano
o riempi vasca o lava piedi



CB|406



Stunning design, both indoor and outdoor
Design accattivante per interni ed esterni



CB400



CB406



CB|432



High volume thermostatic cartridges
Cartucce termostatiche ad alta portata



CB431



CB432



CB|438
+
SO|607



CB436



CB437



CB438



CB448

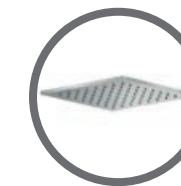

SHOWER HEADS - SOFFIONI - p. 111

Wide choice of shower heads
Ampia scelta di soffioni





CB|513+514



Wall mounted, floor mounted or
deck mounted bathtub fillers
Comandi per bordo vasca da muro,
da piano o da pavimento



CB501



CB502



CB513



CB514

WHY SOLID STAINLESS STEEL?

The beauty and features of stainless steel made it the perfect choice for many sculptures and landmarks such as the pinnacle of the Chrysler building in New York, the Gateway Arch that defines the St. Louis skyline and the Atomium in Brussels. The same characteristics make it the best choice for many industrial and commercial applications including production of high quality fixtures for the bathroom, kitchen and outdoors.

In 1998 MGS manufactured the very first stainless steel mixer for domestic use. No other manufacturer before MGS used it for this purpose due to costs and technical difficulties: stainless steel is more expensive than brass and complex to exploit due to its hardness and higher melting temperature. These factors did not stop MGS because the goal was to offer our customers the best possible products.

The following is a partial list of the exceptional advantages that stainless steel offers.

- It is 100% lead free, which allowed MGS to be the first European manufacturer to be certified in compliance with NSF61 Annex G. This also meets the low lead requirements of the U.S. Safe Drinking Water Act, which entered into effect in January 2014.
- The finish is obtained through hand polishing rather than through chemical processes such as chroming or plating. Polished stainless is extremely scratch resistant and durable.
- It is 100% recyclable and a high percentage of it comes from recycled material (approximately 60%).
- Stainless steel does not release nickel and therefore it is ideal for people allergic to it.
- The non-porous surface is more resistant to bacteria and germs making it a more hygienic choice in the kitchen or bathroom.
- It is ideal for outdoor installation as AISI316 marine grade stainless steel is resistant to oxidation.
- It guarantees a long life cycle, making it the least expensive choice in the long run.

Some competitors now use stainless steel sheet or tubes to cover an inner brass body. This shortcut may provide the possibility to keep production costs lower while offering some of the advantages mentioned above, but clearly not all!

I VANTAGGI DELL'ACCIAIO INOX - AISI316

La bellezza, durezza e durata dell'acciaio inossidabile ne hanno motivato la scelta per la realizzazione di strutture architettoniche quali il pinnacolo dell'Empire State Building a New York e il monumentale atomo di Bruxelles. Le caratteristiche estetiche e qualitative fanno dell'acciaio inossidabile un materiale particolarmente adatto per rubinetti da bagno, da cucina e per esterni. Nessun fabbricante l'aveva mai preso in considerazione prima di MGS perché caro e dalla lavorazione complessa.

Questa è una lista delle prerogative che offre l'acciaio inossidabile:

- È completamente esente da piombo, ciò ha permesso a MGS di essere il primo fabbricante europeo a ottenere la certificazione NSF61-G che vieta la presenza di piombo nei rubinetti per acqua potabile. La norma è entrata in vigore il 1° Gennaio 2014 in tutti gli Stati Uniti perché il piombo è un metallo tossico, nocivo alla salute e all'ambiente.
- È 100% riciclabile e circa il 60% di acciaio è ottenuto da prodotto riciclato.
- La finitura è ottenuta tramite lucidatura a mano, più onerosa ma più duratura e meno deteriorabile della cromatura.
- La superficie non porosa resiste a germi e batteri per una maggiore igiene in cucina e in bagno
- Non rilascia nichel ed è quindi indicato per le persone allergiche a questo metallo.
- Particolarmente resistente all'ossidazione, AISI316 è ideale per l'utilizzo all'aperto.
- È la scelta più economica per la sua durata nel tempo.

Alcuni fabbricanti usano rivestire in acciaio i loro prodotti in ottone ma si tratta ovviamente di accorgimenti estetici che nascondono pur sempre un cuore in ottone.



MINIMAL

COLLECTION

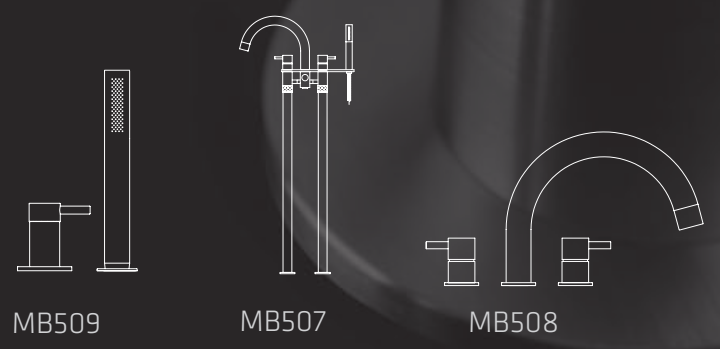

MB509 MB507 MB508

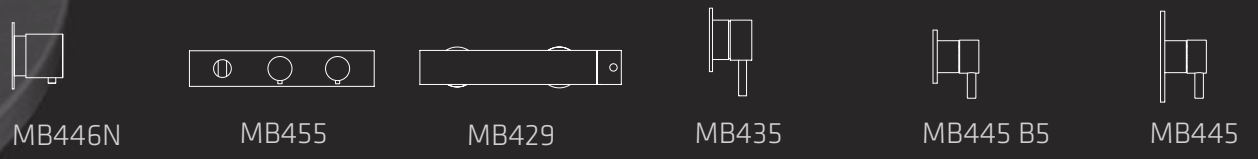

MB446N MB455 MB429 MB435 MB445 B5 MB445

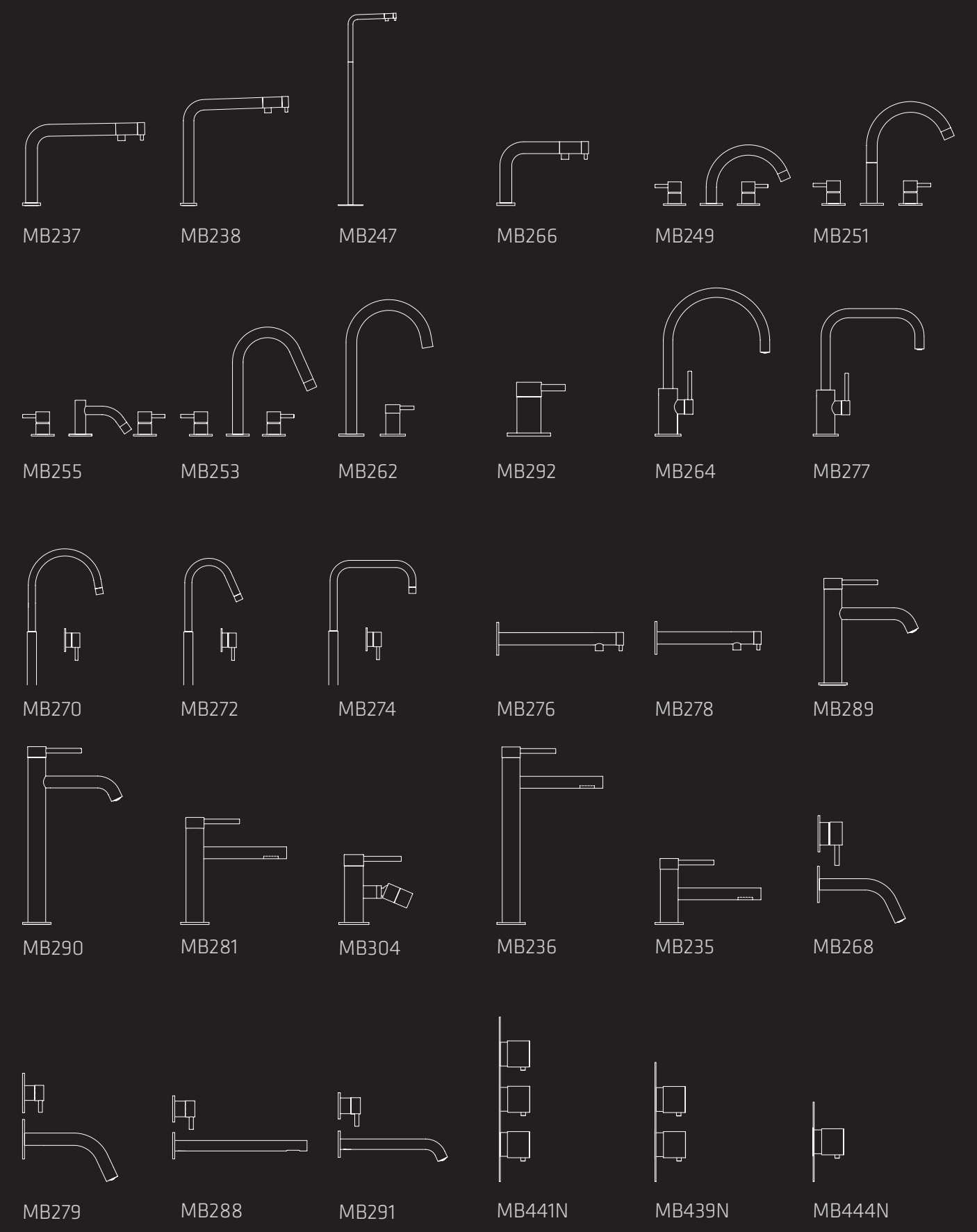

MB237 MB238 MB247 MB266 MB249 MB251

MB255 MB253 MB262 MB292 MB264 MB277

MB270 MB272 MB274 MB276 MB278 MB289

MB290 MB281 MB304 MB236 MB235 MB268

MB279 MB288 MB291 MB441N MB439N MB444N



MB|238



Innovative design
Design innovativo



Single hole mixer with lever on the head
Miscelatore monoforo con comando
in testa



MB237



MB238



MB247



MB266



MB|251



Three hole faucets with independent controls
Rubinetti tre fori con comandi indipendenti



MB249



MB251



MB255



MB253

MB|262



MB262



MB292



MB264



MB277



MB|274

Floor mounted spout with wall mounted mixer
Canna da pavimento con miscelatore a parete



MB270



MB272



MB274



MB|278



Wall mounted mixer with lever on the head
Miscelatore da muro con comando in testa

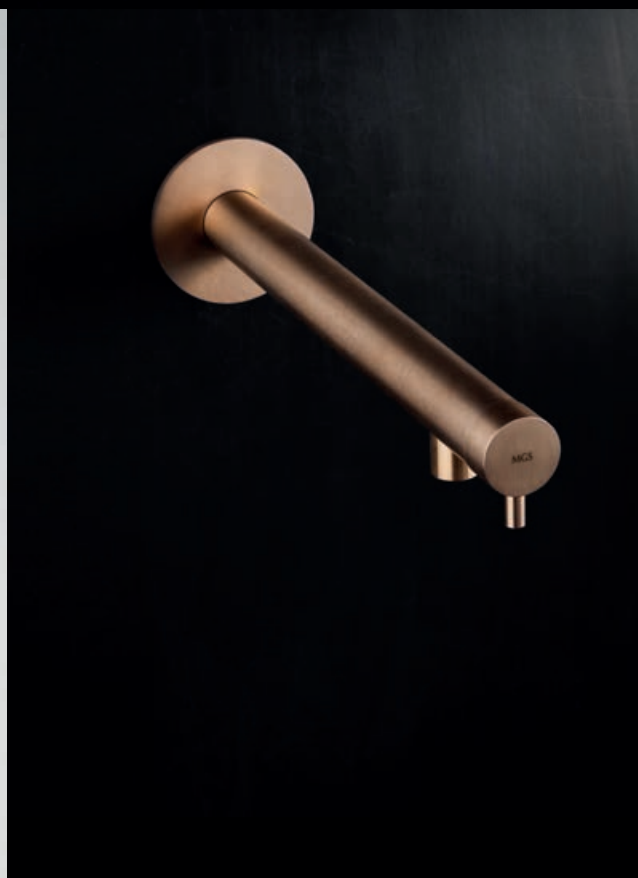

MB276



MB278



MB|289



MB289



MB290



MB235/MB245



MB236



MB304



MB281



MB|291



The wall mounted mixer can be freely positioned
Il miscelatore può essere posizionato a gradimento



MB268



MB279



MB288



MB291

MB|440N



Thermostatic shower valves
with volume controls:

- MB439N : single way volume control
- MB440N : controls two water outlets
- MB449N : controls three water outlets
- MB441N : controls two water outlets
- MB442N : controls three water outlets
- MB443N : controls four water outlets



Valvole doccia termostatiche
con rubinetti di chiusura:

- MB439N : controlla una uscita acqua
- MB440N : controlla due uscite acqua
- MB449N : controlla tre uscite acqua
- MB441N : controlla due uscite acqua
- MB442N : controlla tre uscite acqua
- MB443N : controlla quattro uscite acqua



MB441N/MB442N/
MB443N



MB446N/MB704



MB444N



MB439N/MB440N/
MB449N



MB|455



Horizontal thermostatic valve with hand shower support
 Miselatore termostatico orizzontale con supporto per doccia



MB455

Two ways, controls the hand shower plus a second water outlet
 Due vie, controlla la doccia più una seconda uscita acqua



MB456

Three ways, controls the hand shower plus two additional water outlets
 Tre vie, controlla la doccia più due uscite acqua

MB|445 B5

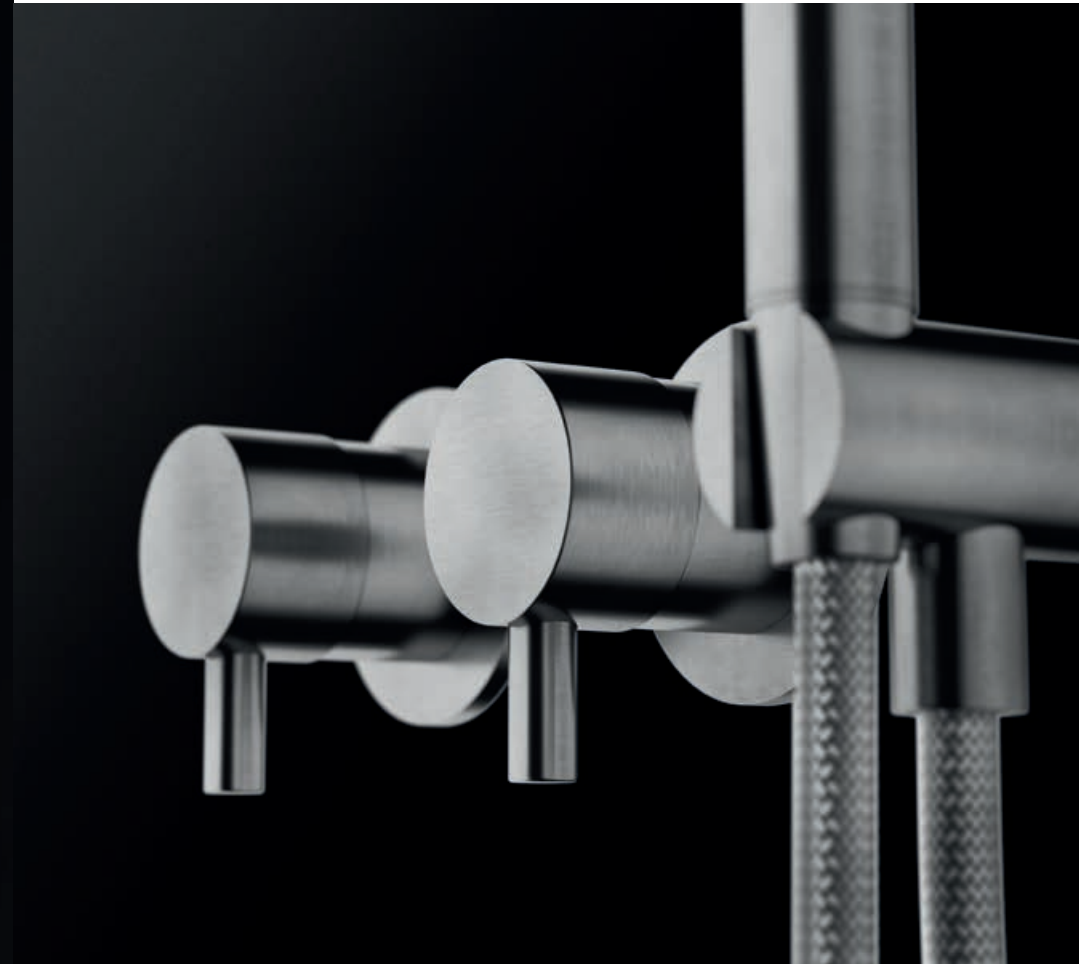

DE700

Two way diverter
Deviatore due vie



DE702

Three way diverter
Deviatore tre vie



MB429



MB435

Wall mounted mixer
Miscelatore da muro



MB445 B5

Wall mounted mixer
Miscelatore da muro



MB445

Wall mounted mixer
Miscelatore da muro

MB|507



Bathtub filler
with high flow rate 3/4" valves
Comandi per bordo vasca
con valvole ad alta portata da 3/4"



MB508



MB509



MB507



MB|510



MB510

MB510 - bathtub filler with hand shower control. Water outlet integrated in the body.
 MB510 - Bordo vasca da muro con comando doccia. Uscita acqua integrata nel corpo



MB511

MB511 - Wall mounted bathtub filler featuring a small mixer with high flow rate. Can be completed with a separate mixer and hand shower
 MB511 - Miscelatore da muro per vasca da bagno: piccole dimensioni ma grande portata. Può essere completato con miscelatore e doccia di cortesia

ERGON

COLLECTION

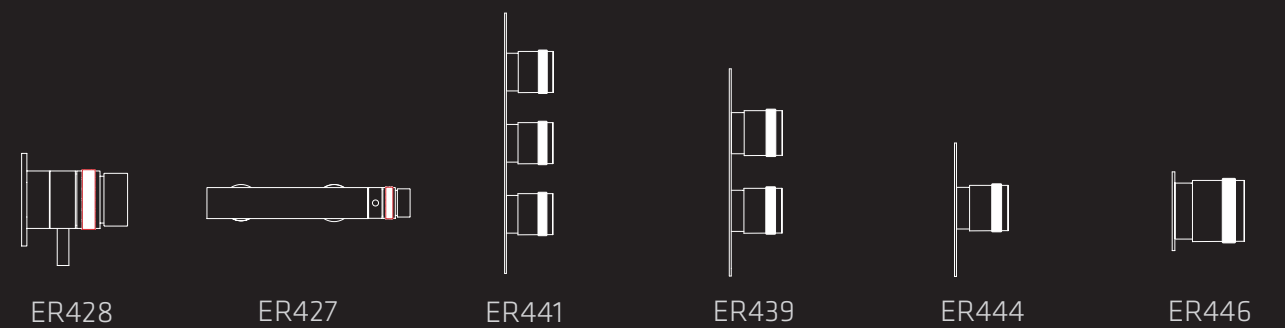
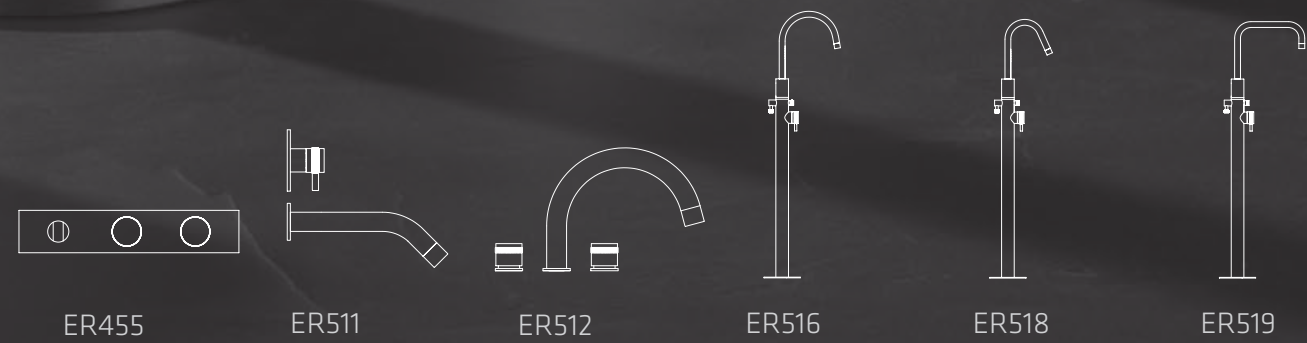
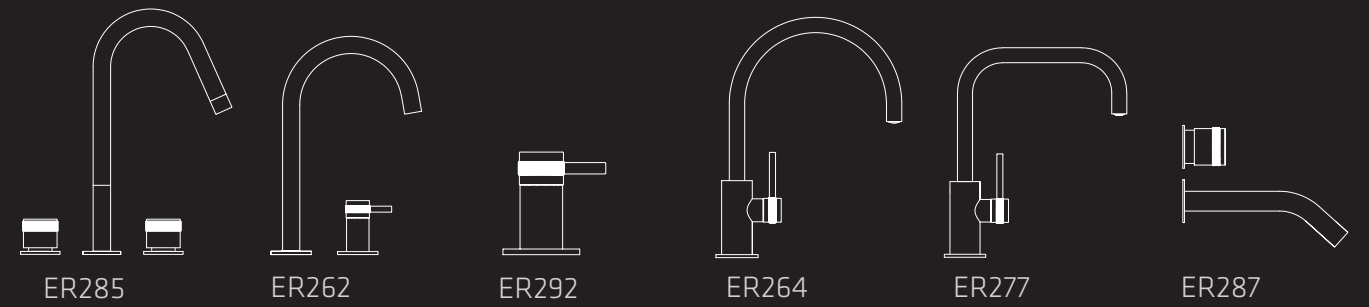
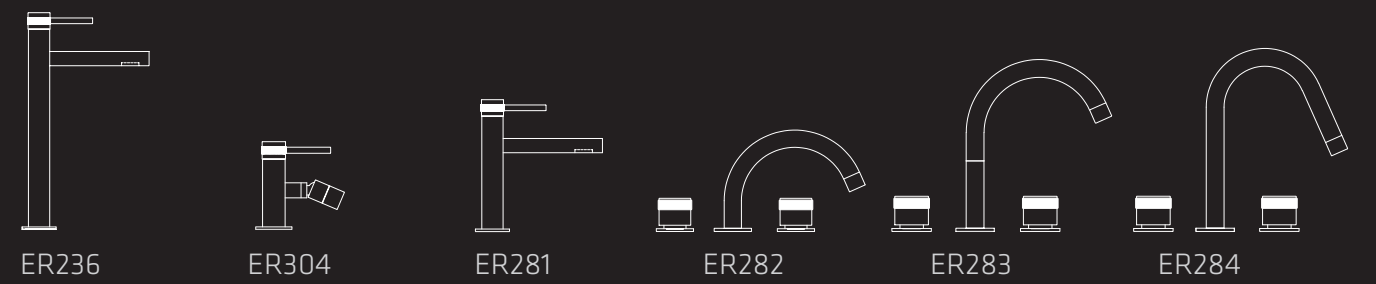
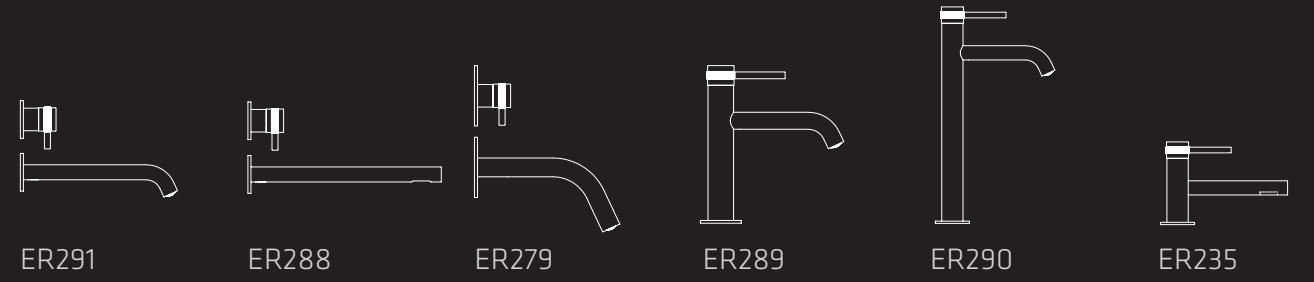
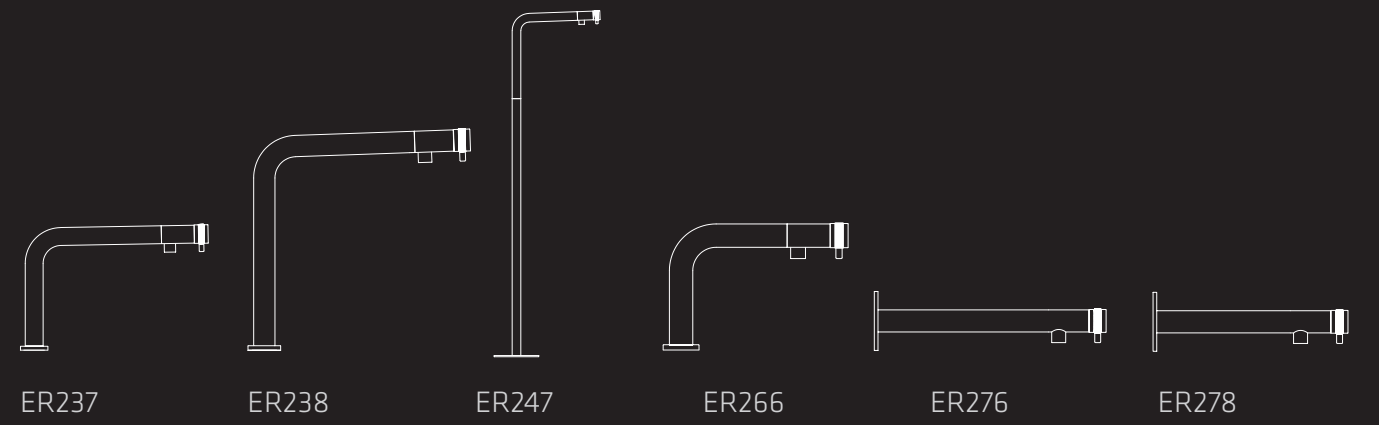



ER|238



Single hole mixer with handle on the head.
Can be installed with or without lever.
Miscelatore monoforo con comando in testa. Può essere installato con o senza leva



ER237



ER238



ER247



ER266



ER|278



ER276



ER278



ER|291



ER291



ER288



ER279





ER|289



ER289



ER290



ER235 / ER245



ER236



ER304



ER281

ER|282



High precision knurling for ease of use, even with wet hands
La zigrinatura ad alta precisione migliora la presa con le mani bagnate



ER282



ER283



ER284



ER285

ER|262



ER262



ER292



ER264



ER277



ER|287



ER287



ER|428

Refined precision machining
Lavorazioni ad alta precisione



ER445



ER428

In line thermostatic mixer
Miscelatore termostatico



ER427

Thermostatic exposed shower
Miscelatore termostatico da muro



ER445 B5

ER|441

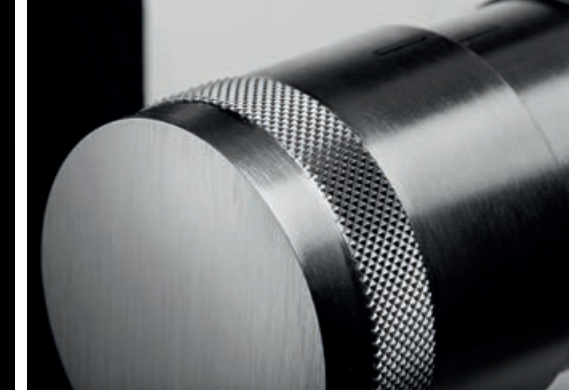

Thermostatic shower valves
with volume controls:

- ER439 : single way volume control
- ER440 : controls two water outlets
- ER449 : controls three water outlets
- ER441 : controls two water outlets
- ER442 : controls three water outlets
- ER443 : controls four water outlets

Valvole doccia termostatiche
con rubinetti di chiusura:

- ER439 : controlla una uscita acqua
- ER440 : controlla due uscite acqua
- ER449 : controlla tre uscite acqua
- ER441 : controlla due uscite acqua
- ER442 : controlla tre uscite acqua
- ER443 : controlla quattro uscite acqua



ER441 / ER442 /
ER443



ER439/ER440/
ER449



ER446/ER704



ER444



ER|455

Horizontal thermostatic valve
with hand shower support
Miscelatore termostatico orizzontale
con supporto per doccia



ER455

Two ways, controls the hand
shower plus a second water outlet
Due vie, controlla la doccia
più una seconda uscita acqua



ER456

Three ways, controls the hand shower
plus two additional water outlets
Tre vie, controlla la doccia
più due uscite acqua



Bathtub filler with
knurled handles - 3/4" valves
Rubinetto per vasca da bagno
con maniglie zigrinate - valvole da 3/4"



ER|512



ER511

ER512

ER|516



The high volume capacity of these free standing bathtub columns makes them ideal for large bathtubs
Colonne vasca free standing, ideali per vasche di grandi dimensioni grazie all'alta portata d'acqua



ER516



ER518



ER519



THE GREEN CHOICE

Stainless steel is an eco-friendly material, in fact it is 100% recyclable and approximately 60% of it comes from recycled material. This percentage is expected to increase in the future. In case that, in spite of its high recyclability, a stainless steel object should end into a disposal site, unlike many other metals it will have no damaging effects on soil and water. Unlike typically used brass, stainless steel does not contain any lead, a poisonous metal that is gradually being abandoned for its detrimental impact.

Stainless steel objects have a very long life cycle. Most likely many years from now, when you will be getting tired of the style of your bathroom, your MGS fixtures will still be as beautiful as when you purchased them.

The MGS production process is extremely clean and eco-friendly. A typical fixture is going to be plated to a polished chrome or matte finish, this process produces toxic wastes that must be properly treated. The beautiful and long lasting finish of our stainless steel fixtures is obtained through hand polishing, a completely non polluting process.

L'acciaio inossidabile è ecologico, al 100% riciclabile e circa il 60% della produzione mondiale deriva da materiale riciclato: percentuale destinata a crescere. Diversamente da altre leghe, se dell'acciaio fosse abbandonato in natura non ne deriverebbe nessun danno all'ambiente, al terreno o alle falde acquifere: l'acciaio inossidabile non si deteriora e non inquina.

Il processo di produzione di MGS è pulito ed ecologico: un comune rubinetto viene cromato col rischio di provocare rifiuti tossici dannosi mentre i nostri rubinetti in acciaio inossidabile sono unicamente lucidati a mano. Gli oggetti in acciaio inossidabile sono di durata praticamente illimitata e quando vi sarete stancati del vostro bagno e vorrete rinnovarlo, la vostra rubinetteria in acciaio inossidabile sarà ancora come nuova, inalterata.

*Anna
Anjo!*



OUTDOOR

Being produced in of marine grade stainless steel AISI316, the entire MGS range is ideal for outdoor installation. Stainless steel is extremely resistant to oxidation, but in the event of superficial oxidation, the use of specific stainless steel cleaners can restore the finish to its original flawless state. Chrome plating on the contrary once impaired cannot be restored.

MGS - Timeless beauty indoor and outdoor.

L'intera gamma MGS è in acciaio inossidabile massiccio AISI316, resistente all'ossidazione e pertanto adatta all'installazione all'aperto. Qualora dovessero palesarsi tracce di ossidazione, appositi liquidi per la pulitura dell'acciaio gli restituiscono l'originale brillantezza. Diversamente dall'acciaio inossidabile, le cromature intaccate sono irrecuperabili.

Rubineria MGS, bellezza inalterata nel tempo.



PRODUCTION

As a boutique manufacturer, MGS is driven by: perfectionism, commitment to the highest quality, pride in and passion for the product. Unlike our many competitors, we have never invested in mass production or sought ways to do things faster and cheaper. Combining Swiss engineering standards with Italian design, our goal is to do things better and to be innovative.

Every single part of our faucets is made of solid stainless steel that we shape with computerized machines. The goal of our very strict quality standards is to combine the parts with infinitesimal precision, which will provide for a perfect assembly and a long lasting smooth and flawless use.

Prior to the final assembly the parts are hand polished to a matte or shiny finish by our master stainless steel polishers. This particular procedure requires skills and know-how that are typical of the region where MGS is located.

The seamless finish of the separate parts guarantees that the final product will have an impeccable finish throughout the surface. The faucet is finally ready for assembly and packaging.

Numerous quality controls take place during the process: after machine tooling, polishing, assembly, and final packaging. Every step of the manufacturing process is carefully monitored to ensure that the strictest quality standards are respected.

Our small dynamic team is extremely swift and flexible, which allows us to follow up on special custom-made product requests very quickly.



LA PRODUZIONE

MGS è una boutique della rubinetteria che concepisce e produce rubinetti esclusivi di qualità superiore: non ci dedichiamo né siamo interessati ai grandi numeri che andrebbero a discapito del concetto di produzione limitata ma di altissima qualità.

Combinando lo standard ingegneristico svizzero e il design italiano, il nostro obiettivo è di creare prodotti migliori e innovativi. Le varie parti dei nostri rubinetti sono in acciaio inossidabile che modelliamo con torni elettronici ad alta precisione, ottenendo assemblaggi perfetti per un uso morbido e duraturo del prodotto. Prima dell'assemblaggio finale, le varie parti che compongono il rubinetto sono lucidate a mano da esperti lucidatori che grazie alla loro esperienza e precisione garantiscono al prodotto finito un aspetto omogeneo. Rigorosi controlli di qualità sono effettuati durante tutto il ciclo di lavorazione per accertare che ogni parametro funzionale ed estetico venga rispettato.

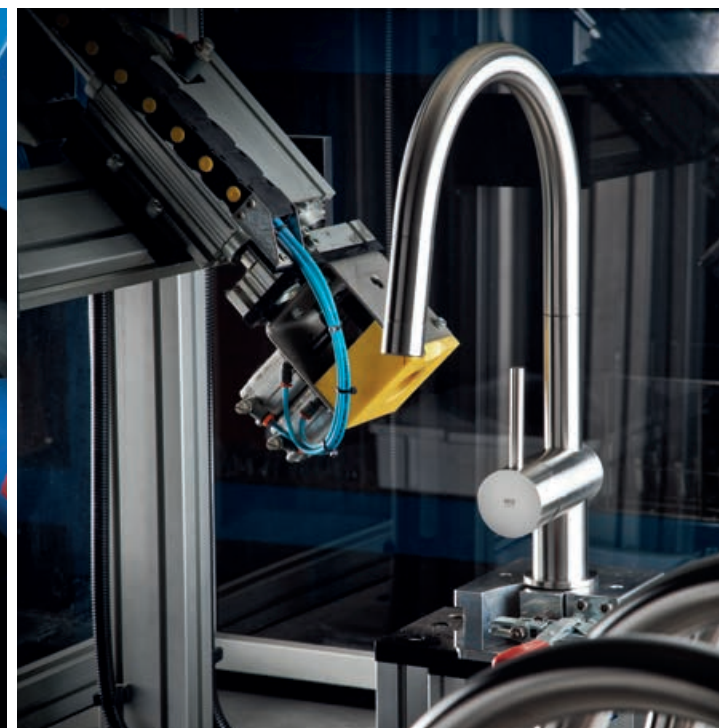

CUSTOM MADE

As a boutique manufacturer, we at MGS love to collaborate with architects and designers: a source of inspiration to create innovative products. Our custom made division allows them the freedom to creatively use their knowledge and talents by customizing products which fit the personality and lifestyle of each individual homeowner. We cater to that special customer that craves a unique one of a kind product in their home.



MGS collabora con architetti e progettisti d'interni che sono sempre una sorgente di ispirazione per innovare la nostra gamma. La nostra divisione dedicata ai prodotti speciali permette di dare sfogo alla creatività dei progettisti che possono così esprimere appieno il proprio talento e personalità. MGS è interessata alle esigenze del singolo cliente che desidera dare un tocco di unicità alla propria abitazione.

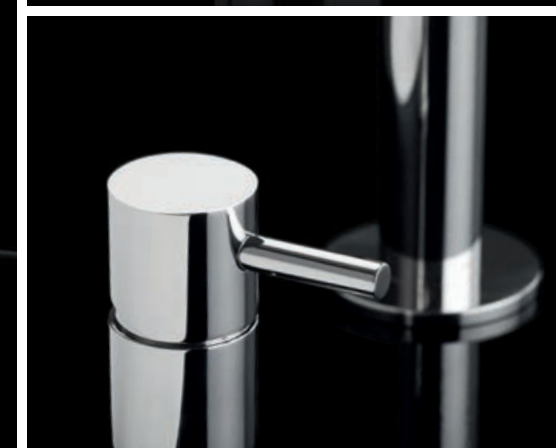

POLISHED STAINLESS STEEL

All products of the bath collection are also available in polished stainless steel. This elegant finish is obtained through additional refined hand polishing over the matte finish.

FINITURA LUCIDA

Tutti i modelli della collezione bagno sono altresì disponibili in acciaio lucido. Questa elegante finitura è ottenuta tramite un'ulteriore lucidatura a mano successiva alla satinatura.



SO|624



S0624



S0625



S0615

400 x 400 mm
15 3/4" x 15 3/4"

Rain effect
Effetto pioggia



S0627

500 x 500 mm
19 3/4" x 19 3/4"



SO|630



S0604

4 mm - 1/6" thickness
Spessore 4 mm - 1/6"



S0607

Ø 200 mm | 7 7/8"



S0617

Ø 300 mm | 11 4/5"

13/15 mm - 2/3" thickness
Spessore 13/15 mm - 2/3"



S0629

Ø 200 mm | 7 7/8"



S0630

Ø 300 mm | 11 4/5"



S0618

Ø 400 mm | 15 3/4"



S0609

200 x 200 mm
7 7/8" x 7 7/8"



S0620

300 x 300 mm
11 4/5" x 11 4/5"



S0608

400 x 400 mm
15 3/4" x 15 3/4"



SO|623



Rain, waterfall, mist, chromotherapy: flush mounted shower heads offer many options in terms of dimensions and functions that allow you to design your dream shower. Contact us in case of specific needs not available in our standard product range

Pioggia, cascata, vaporizzatore, cromoterapia: I soffioni a soffitto offrono molte opzioni in termini di funzioni e dimensioni, permettendo di realizzare la doccia dei vostri sogni. Contattateci qualora siate alla ricerca di modelli con caratteristiche diverse dai nostri prodotti standard



S0613

500 x 500 mm
19 2/3" x 19 2/3"

Rain - waterfall - mist - chromotherapy
Pioggia - cascata - vaporizzatore - cromoterapia



S0614

500 x 500 mm
19 2/3" x 19 2/3"

Rain - waterfall
Pioggia - cascata



S0623

950 x 950 mm
37 3/8" x 37 3/8"

Two rain zones - waterfall - mist - chromotherapy
Due zone pioggia - cascata - vaporizzatore - cromoterapia

SO|612



S0600



S0612

Minimal and elegant shower head featuring a soothing rain effect

Soffione dal design minimalista con abbondante effetto pioggia

SHOWER HEADS - SOFFIONI - p. 111

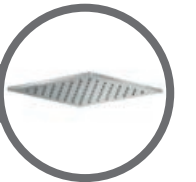

AC989



AC987



AC870



AC973 + S0607

Ceiling mounted arms for shower head
Bracci soffione a soffitto



AC988



AC973



AC988 + S0609

Wall mounted arms for shower head
Bracci soffione a parete

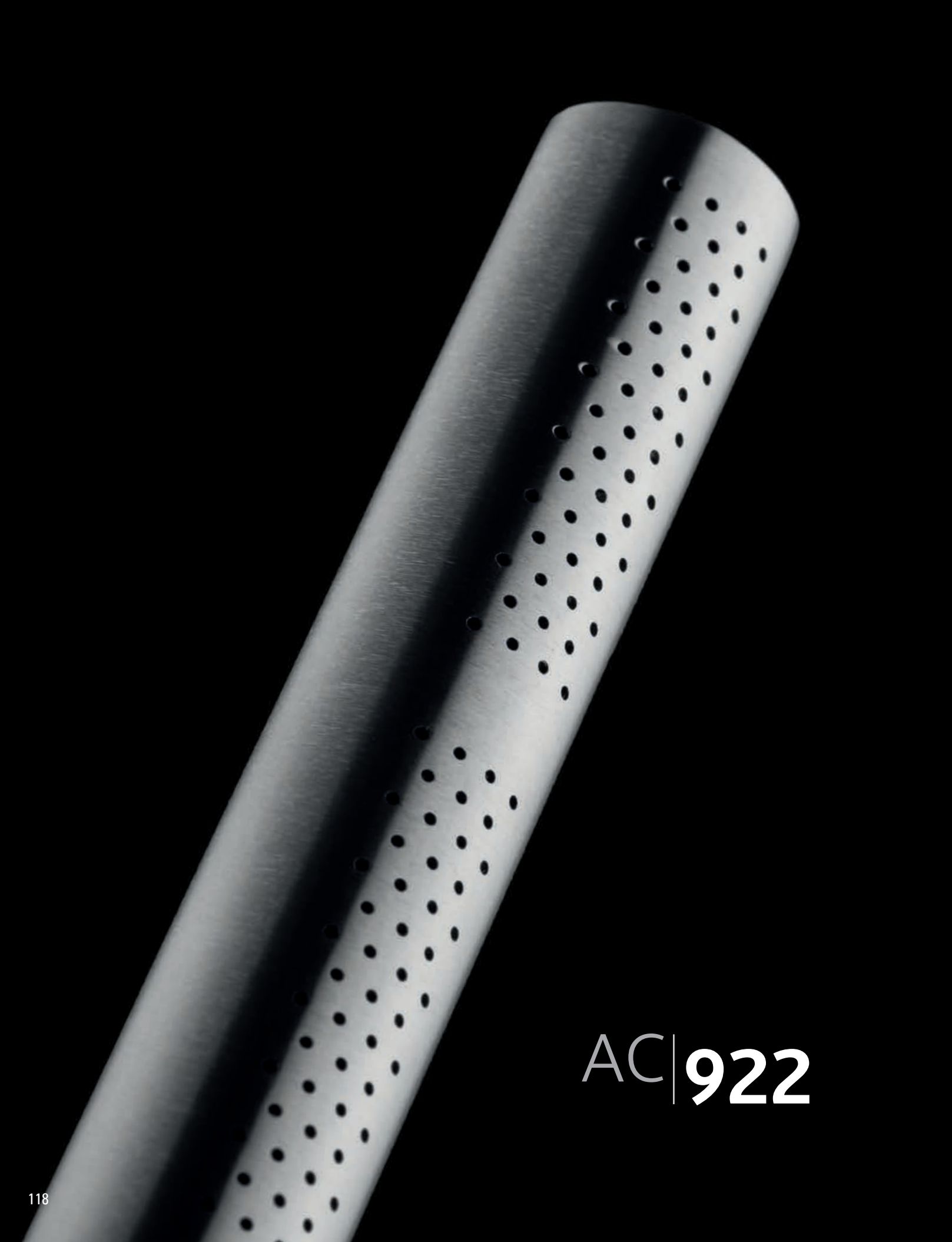

AC|922

Hand shower options
Doccette di cortesia



AC956

Wall mounted hand shower holder
Porta doccetta da muro



AC955

Deck mounted hand shower holder
Porta doccetta da piano



AC920/AC921



AC922/AC923



AC924/AC925

AC|975



Hand shower for WC
Doccetta per WC



AC975



MB435

Wall mounted mixer
Miscelatore da muro



MB445

Wall mounted mixer
Miscelatore da muro



ER446

This WC hand shower must be combined with MB435 or MB445 mixer or MB446 cold water tap
Questa doccetta per WC va abbinata al miscelatore MB435 o MB445 o al rubinetto d'arresto
MB446 per solo acqua fredda



High precision laser cut
Tagli laser a alta precisione



AC960



AC961



AC962



AC963



AC940



AC930



AC931





AC913



AC912



Not simply a toilet brush
Non un semplice spazzolino da WC



AC932



AC933



AC936



AC950



AC935



AC934



AC954



AC951



AC942



AC952



AC964



AC941



AC953



AC977



AC978



AC979



AC980

Floor mounted spout
Canna da pavimento



AC981

Floor mounted spout
Canna da pavimento



AC982

Floor mounted spout
Canna da pavimento



AC983



AC984



AC986



MB292

Deck mounted mixer
Miscelatore da piano



MB435

Wall mounted mixer
Miscelatore da muro



MB445

Wall mounted mixer
Miscelatore da muro



MB515

Deck mounted mixer
Miscelatore da piano



MB445B50

Wall mounted mixer
Miscelatore da muro

AC|991



AC990



AC964



AC991



FINISHES

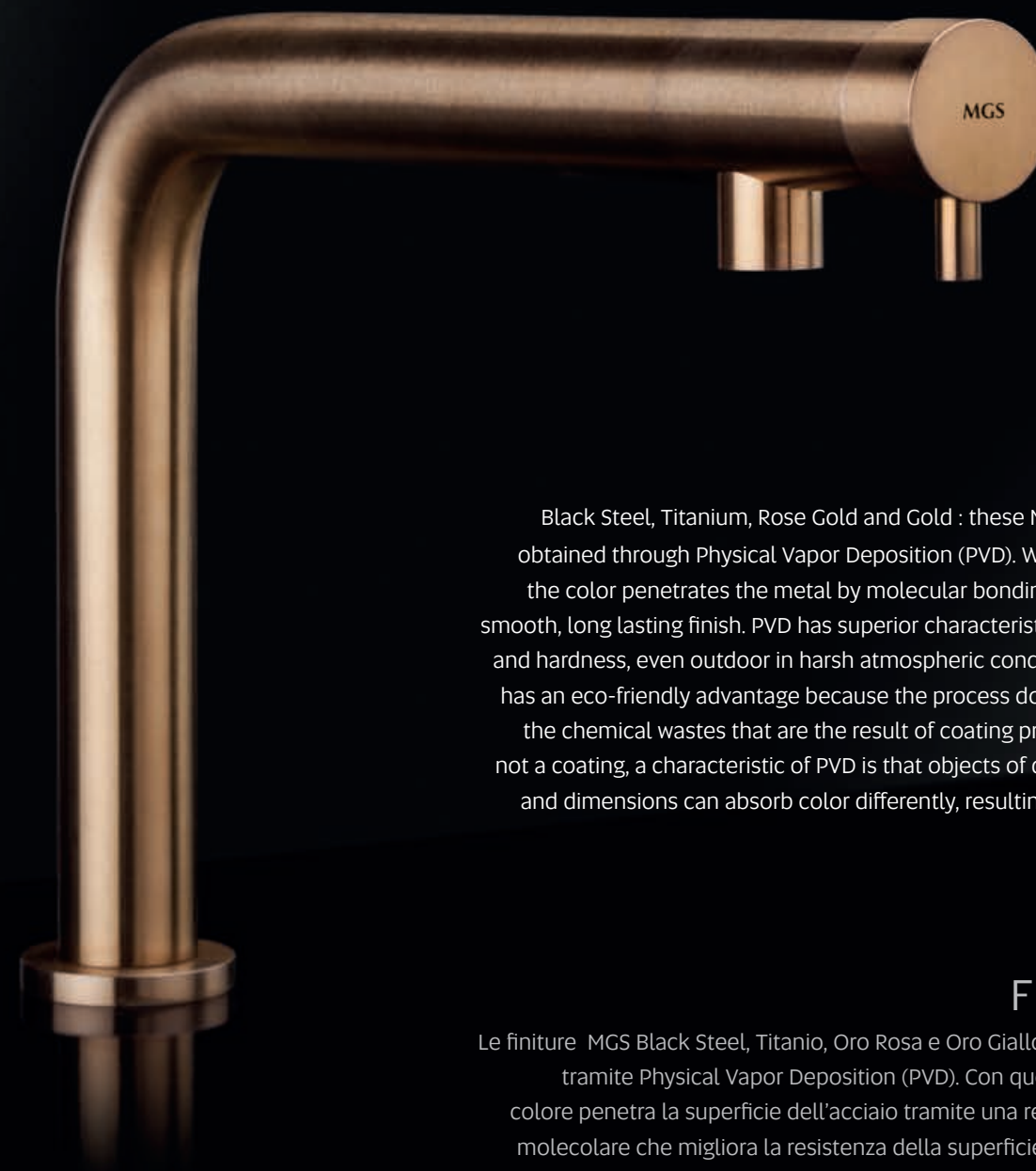

Black Steel, Titanium, Rose Gold and Gold : these MGS finishes are obtained through Physical Vapor Deposition (PVD). With this process the color penetrates the metal by molecular bonding, resulting in a smooth, long lasting finish. PVD has superior characteristics of durability and hardness, even outdoor in harsh atmospheric conditions. PVD also has an eco-friendly advantage because the process does not produce the chemical wastes that are the result of coating processes. As it is not a coating, a characteristic of PVD is that objects of different shapes and dimensions can absorb color differently, resulting in slight color variations.

FINITURE

Le finiture MGS Black Steel, Titanio, Oro Rosa e Oro Giallo sono ottenute tramite Physical Vapor Deposition (PVD). Con questo processo il colore penetra la superficie dell'acciaio tramite una reazione a livello molecolare che migliora la resistenza della superficie. Il trattamento PVD ha ottime caratteristiche di resistenza e durezza, superiori rispetto a finiture galvaniche e verniciature tradizionali, anche per installazioni outdoor.

Inoltre è un processo che non produce alcun tipo di scarti inquinanti, in linea con la filosofia produttiva MGS.

Poiché non è un rivestimento applicato in superficie, una caratteristica del PVD è che oggetti di diverse forme e dimensioni possono assorbire il colore in maniera diversa, risultando in lievi differenze di tonalità.



See our kitchen catalogue or website for our extensive range of kitchen faucets and accessories.
Vi invitiamo a visionare il catalogo cucina o il sito MGS per l'intera gamma di rubinetti e accessori cucina.

© Purcell Murray Inc. 2015

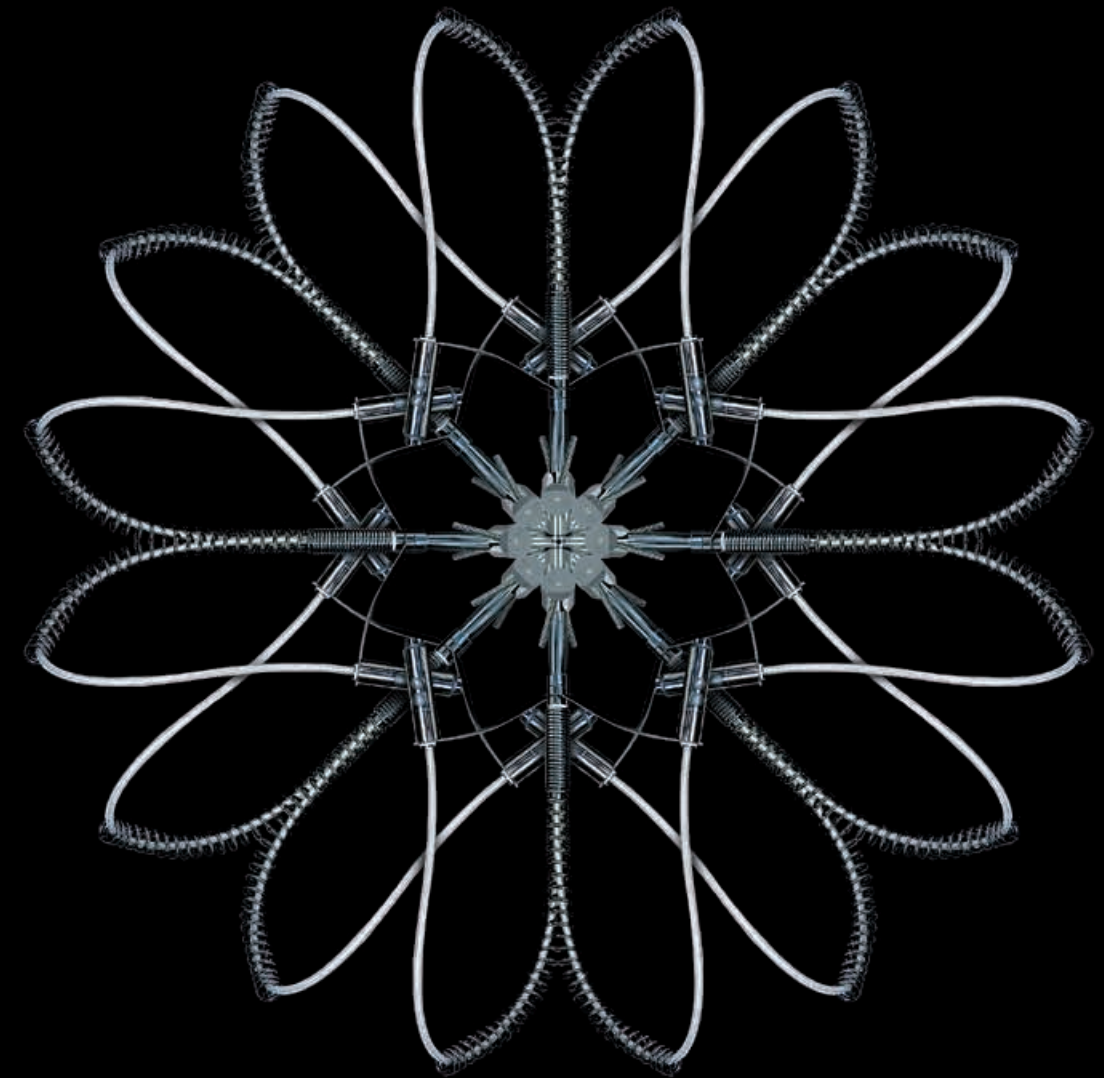

MGS - jewels for bathroom and kitchen
MGS - gioielli per cucina e bagno

Concept, design and photography: Widestudio.it
Illustrations: Anna Anjos

Il fabbricante si riserva il diritto di modificare i prodotti senza preavviso. - The manufacturer has the right to modify the products without forwarding.
Le fabriquant se réserve de modifier les produits sans préavis. - Der Hersteller behält sich das Recht vor, die Produkte ohne Vorankündigung zu ändern.



mgstaps.com